

 **NEST Complete Learning System™**

# THE ANIMATED STORIES FROM THE NEW TESTAMENT®

**Resource & Activity Book**

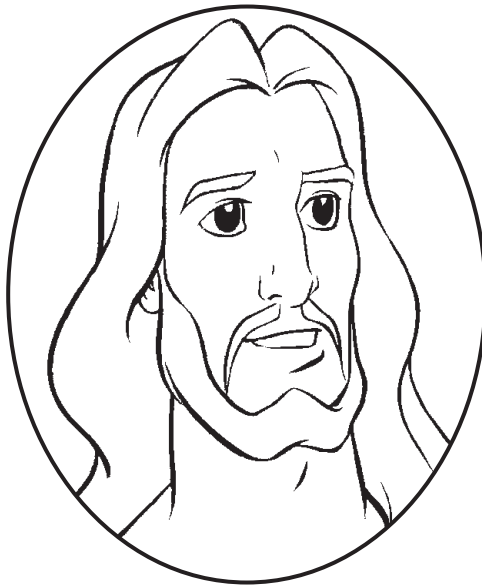

## He is Risen

By: Amy Binder, Andrea DeGeest, Kim Freeberg, Michelle  
Garst,  
Elke Hartleroad, Tony Salerno & Katherine Vawter

 **NEST Family Entertainment™**





# Level One

 **NEST Family Entertainment™**

# Parent and Teacher Guide

Studies have proven learning is enhanced through the use of several senses. A recent study shows that we retain 10 percent of what we see, 20 percent of what we hear, and 50 percent of what we see and hear. But when we see, hear and do, we retain 90 percent of the information.

*(Lisa Marie Nelson, Ph.D., Author "The Healthy Family Handbook").*

The purpose of this Resource & Activity Book is to help children learn and retain the story theme and principles in a fun and educational way. Your children will love coloring pages, solving puzzles, matching games, completing word searches, and much more! Each Resource & Activity Book also features challenging questions and activities for children from preschool through middle school. And in the rare case you don't know an answer, there's an answer key in the back.

## LEVEL OF DIFFICULTY

The activities in this book are designed in three levels of difficulty and segregated into two challenging sections. The Level One section of the book contains activities geared towards younger children while the Level Two section contains activities that are more challenging. Each activity also includes a symbol designating the difficulty level of that activity. The activities with one symbol are easy for most children while the two and three symbol activities become increasingly challenging for older children.



### PERMISSION TO REPRODUCE

This Resource & Activity Book contains proprietary information, which is protected by copyright. All rights are reserved. However, any part of this book may be reproduced for personal or classroom use as long as it is not sold. Such permission does not include the storage of any part of this publication in a retrieval system or the transmission of such, in any form, or by any means, electronic, mechanical, recording, etc., without prior written permission of the publisher. This permission applies only to the printed material in this Resource & Activity Book and does not extend to any audio or video production released or distributed by NEST Family Entertainment™. For additional certificates or Resource & Activity Books, contact: NEST Family Entertainment™, LLC. 1461 S. Beltline Rd., Suite 500, Coppell, TX 75019.

# TABLE of CONTENTS

Parent and Teacher Guide .....	2
Activities & Color Pages:	
<i>Color Page - A stone covers...</i> .....	5
<i>Match the Shapes</i> .....	6
<i>Color Page - Jesus' tomb is sealed...</i> .....	7
<i>Color Page - The women decide...</i> .....	8
<i>Dot to Dot</i> .....	9
<i>Color Page - The women tell the disciples...</i> .....	10
<i>Color the Shapes</i> .....	11
<i>Color Page - Jesus appears to Mary...</i> .....	12
<i>Word Puzzle</i> .....	13
<i>Color Page - Mary Magdalene tells...</i> .....	14
<i>The Empty Tomb</i> .....	15
<i>Color Page - The disciples run...</i> .....	16
<i>Find the Words</i> .....	17
<i>Color Page - Thomas sees Jesus...</i> .....	18
<i>Trace and Color</i> .....	19
<i>Color Page - "Blessed are those..."</i> .....	20
<i>Color Page - "Cast the nets..."</i> .....	21
<i>Find the Fish</i> .....	22
<i>Color Page - Jesus talks to Simon...</i> .....	23
<i>Does It Belong?</i> .....	24
<i>Color Page - "This same Jesus..."</i> .....	25
Level One Answer Key .....	A1-A2
Scriptural References .....	B1-B3
Level One Certificate of Achievement .....	C1



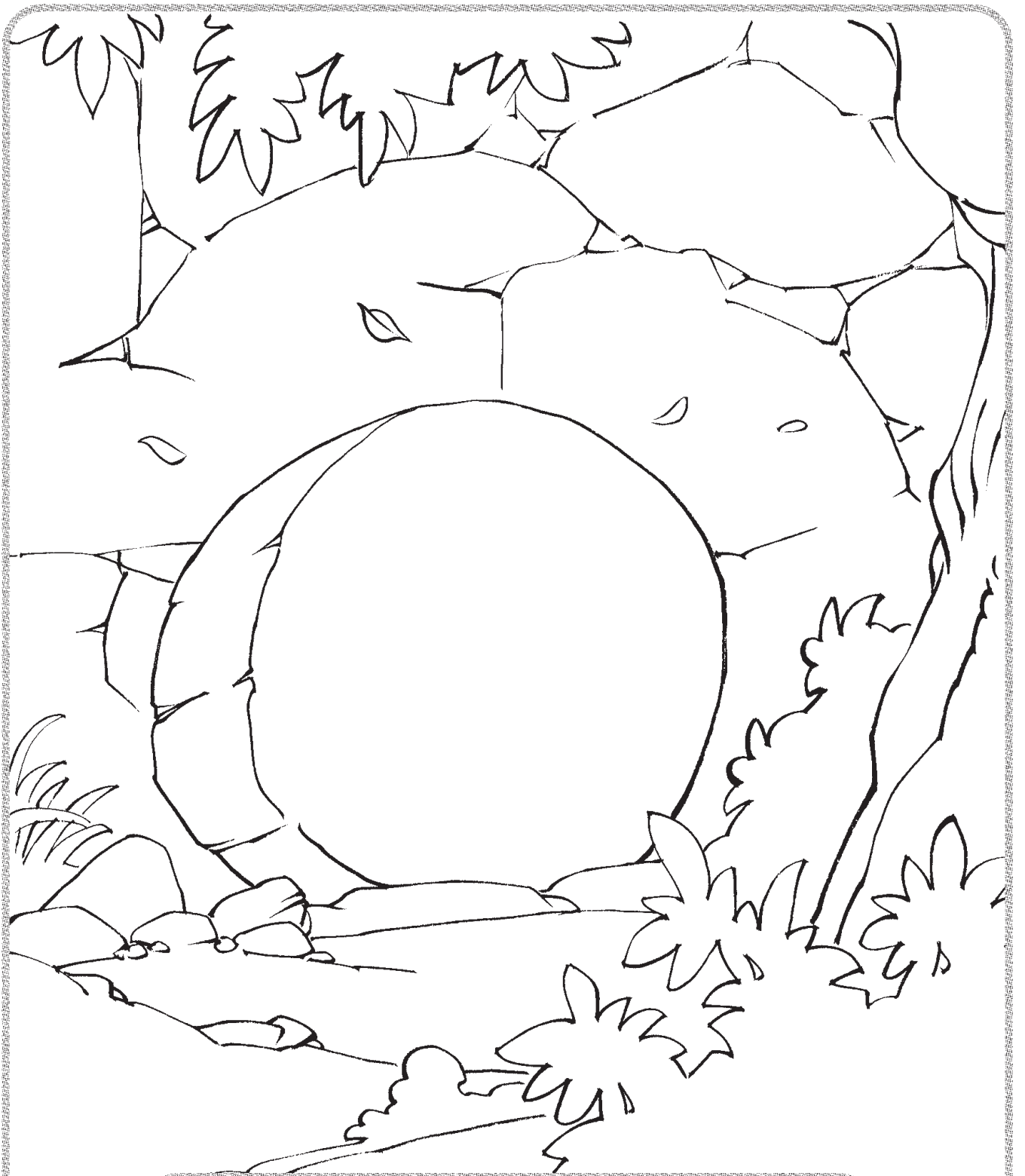

A stone covers the doorway  
to Jesus' tomb.

*Matthew 27:60; Mark 15:46*

# Match the Shapes

Draw a line between the matching shapes. Color the pictures.

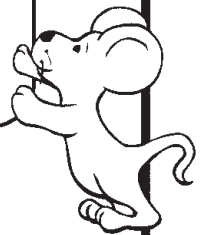
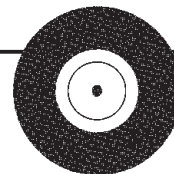
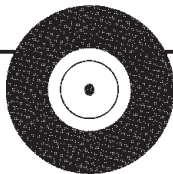
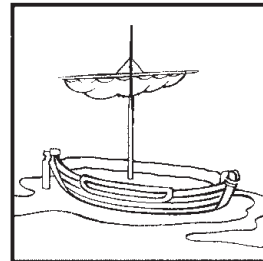
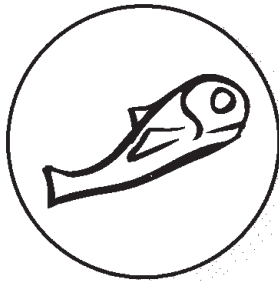
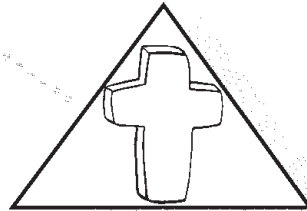
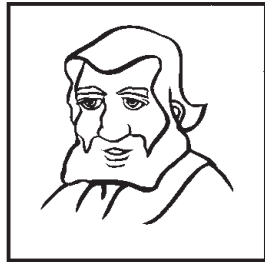
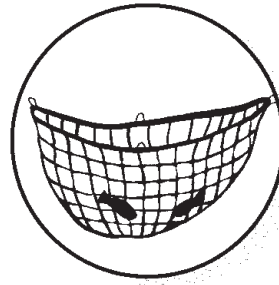
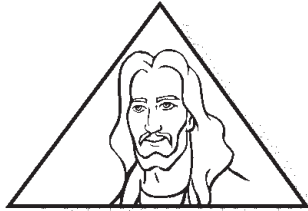





Jesus' tomb is sealed by Rome.  
*Matthew 27:62-66*



The women decide to go to the tomb.

*Mark 16:1, Luke 24:1*

# Dot • to • Dot

“For God so loved the world that he gave his only begotten Son.” Follow the alphabet in order and draw a line from dot to dot. Complete the picture and color it.

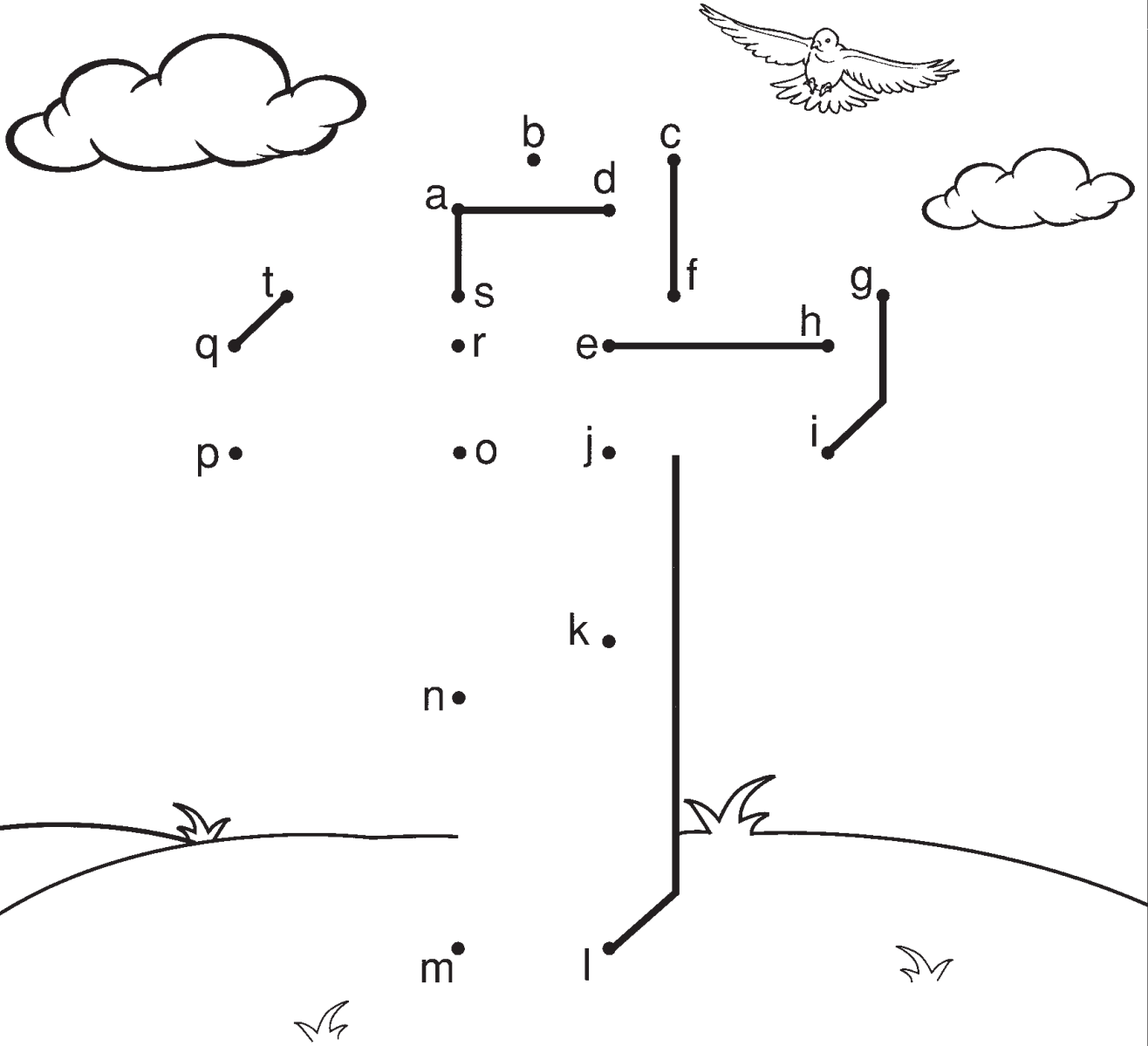

John 3:16



The women tell the disciples  
that Jesus has risen.

*Matthew 28:8; Luke 24:9-10*

# Color the Shapes

Color each shape that looks like a circle.

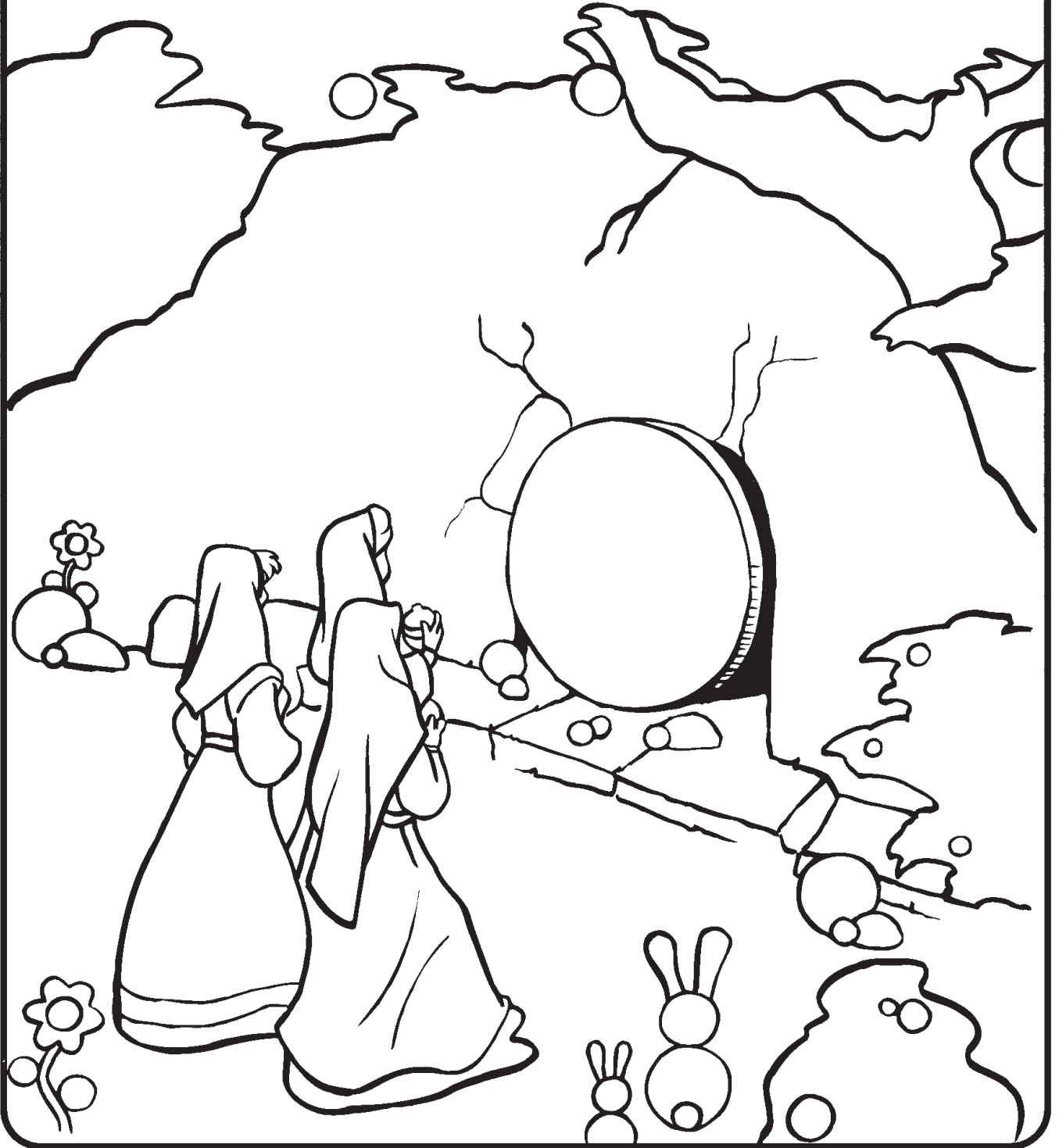

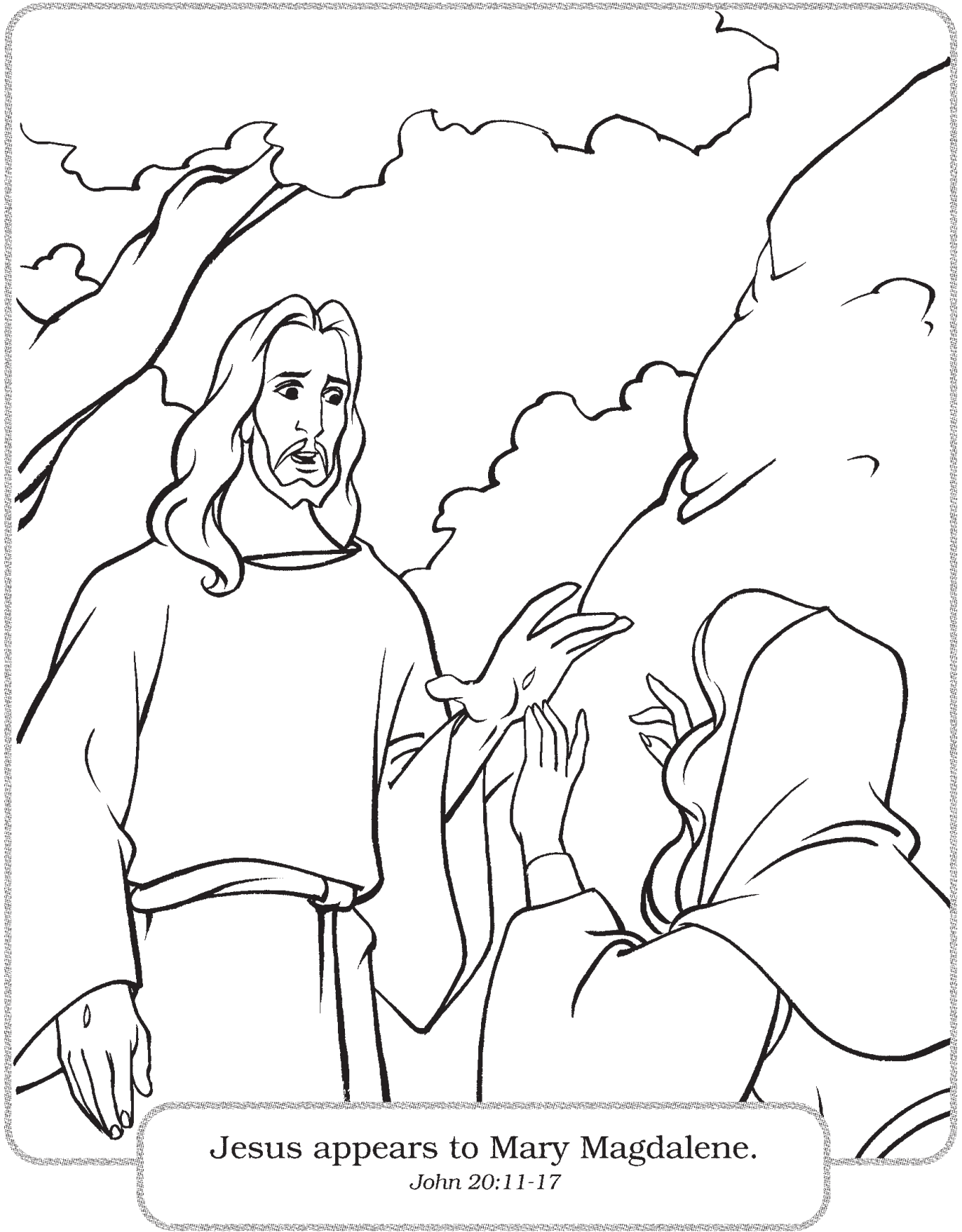

Jesus appears to Mary Magdalene.

*John 20:11-17*

# Word Puzzle

Find and circle all of the words in the puzzle below. The words are listed above the puzzle. The first one has been done for you.

✓boat      eat  
good      fish  
cook      net

b	o	a	t	g
f	i	s	h	o
c	o	o	k	o
n	e	t	o	d
e	e	a	t	o

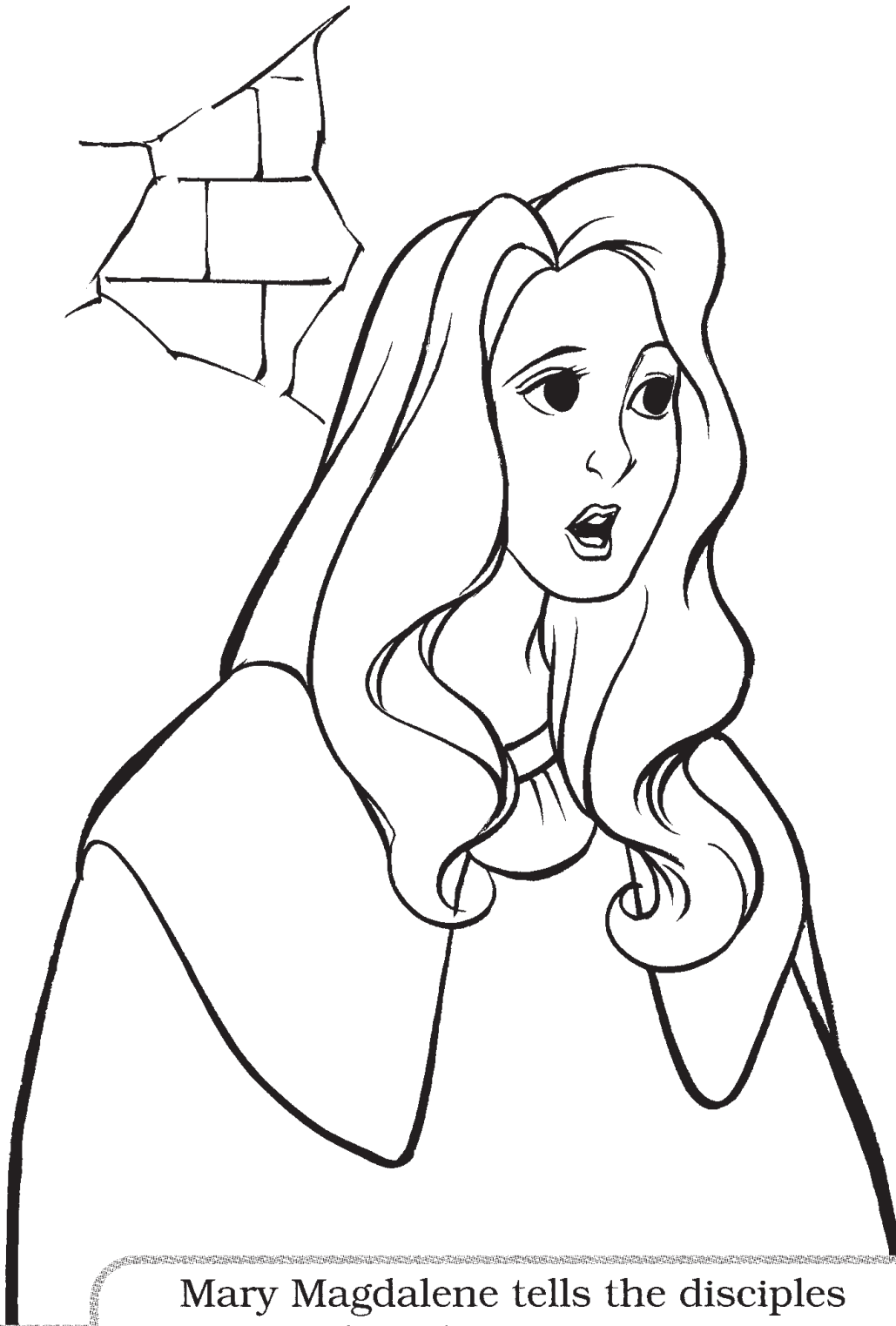

Mary Magdalene tells the disciples  
that she saw Jesus.

*John 20:18*



# The Empty Tomb

Help Jesus' friends go to the empty tomb.

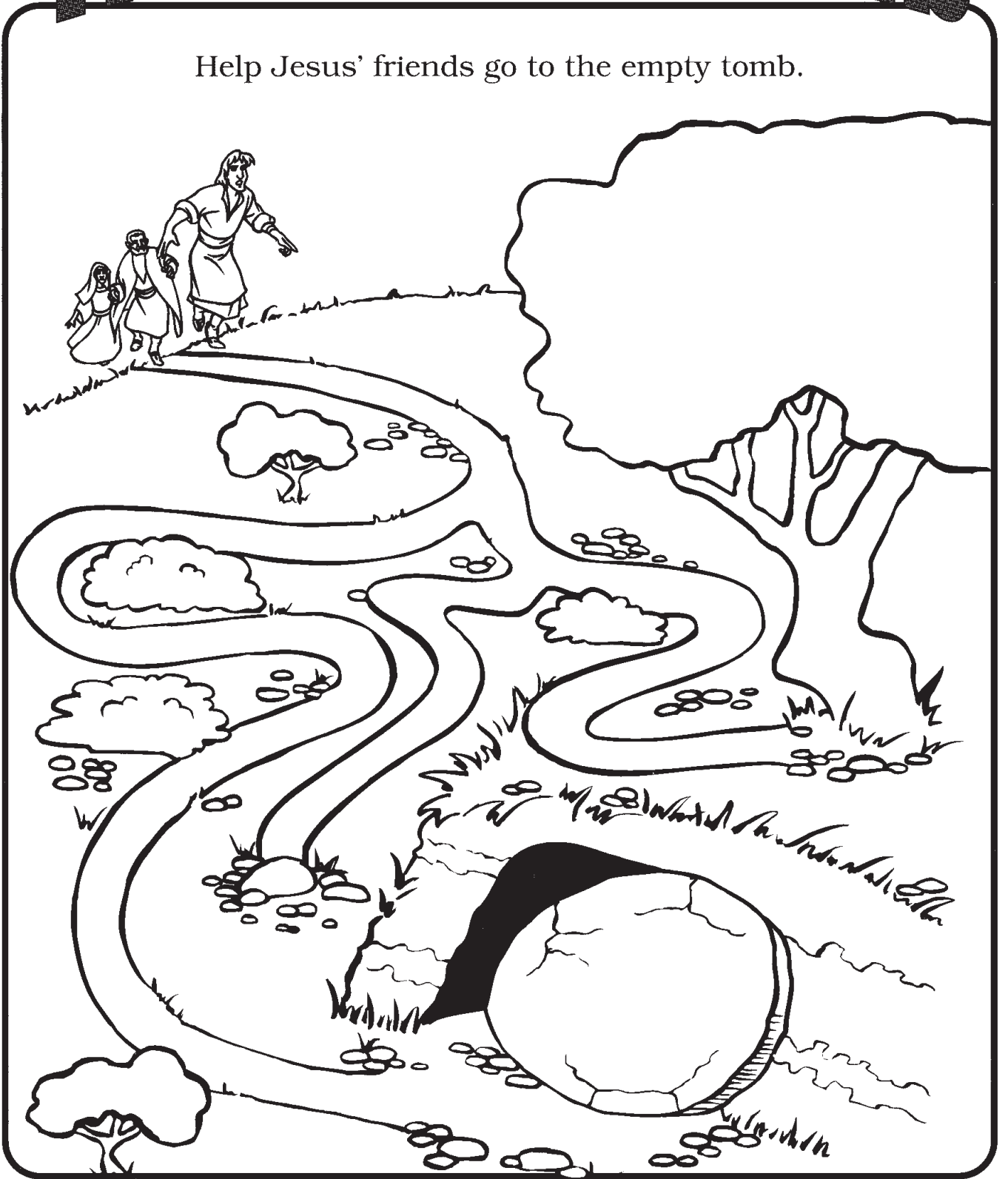

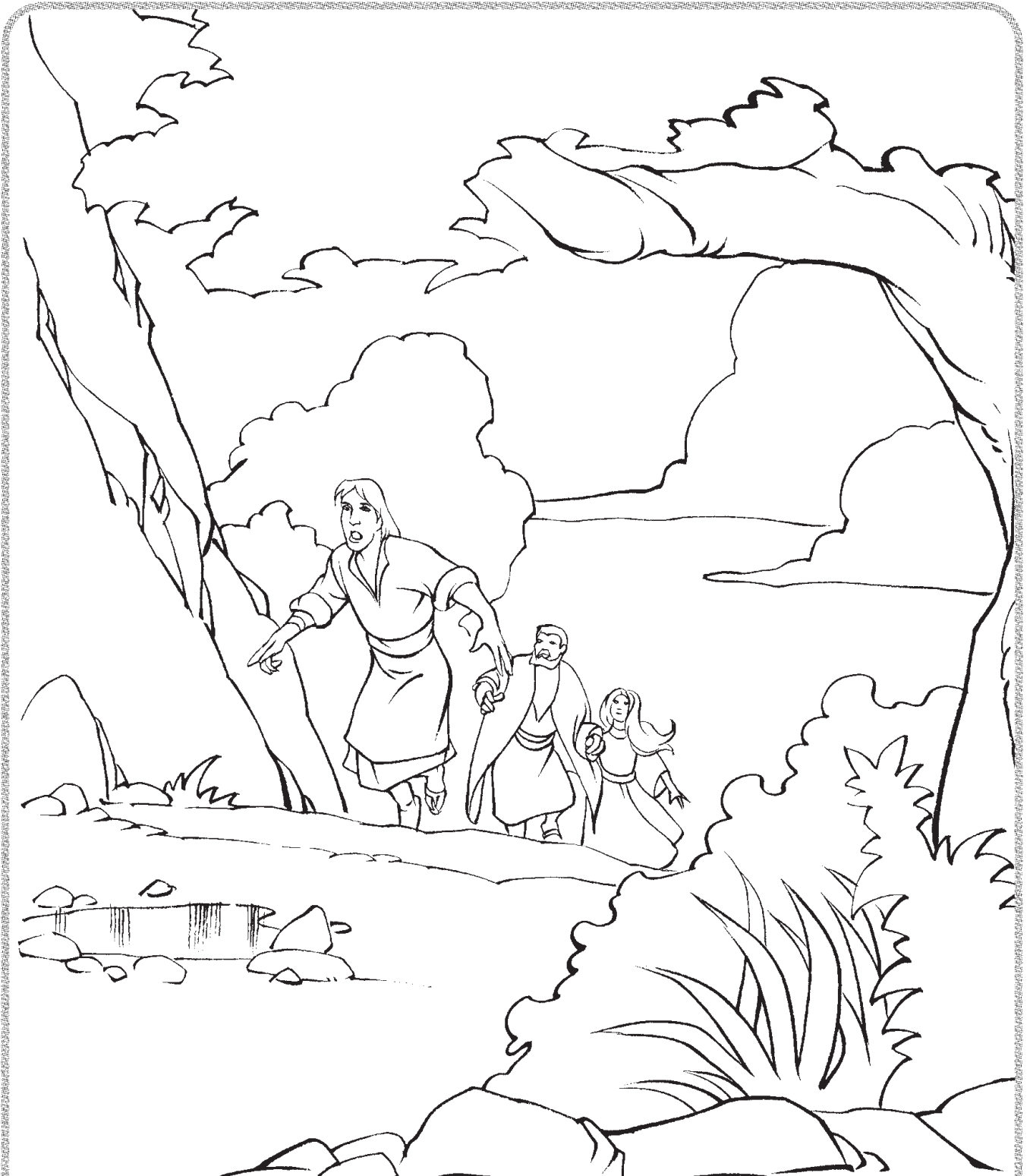

The disciples run to the empty tomb.

*Luke 24:12; John 20:3-8*

# Find the Words

Follow each step below to find who Jesus died for on the cross.

**Step 1:** In the line below, cross out all the A's.

A J E A S U S

Write the letters that are left in the blanks below.

\_\_\_\_\_

**Step 2:** In the line below, cross out all the B's.

B D I B E D B

Write the letters that are left in the blanks below.

\_\_\_\_\_

**Step 3:** In the line below, cross out all the C's.

C F C O C R C

Write the letters that are left in the blanks below.

\_\_\_\_\_

**Step 4:** In the line below, cross out all the D's.

D D M D E D D

Write the letters that are left in the blanks below.

\_\_\_\_\_.



Thank you,  
Jesus!

Read all the words together to find who Jesus died for on the cross.



Thomas sees Jesus.

*John 20:24-29*

# Trace and Color

Trace the name and color the picture.



Mary



Jesus



Paul



Peter

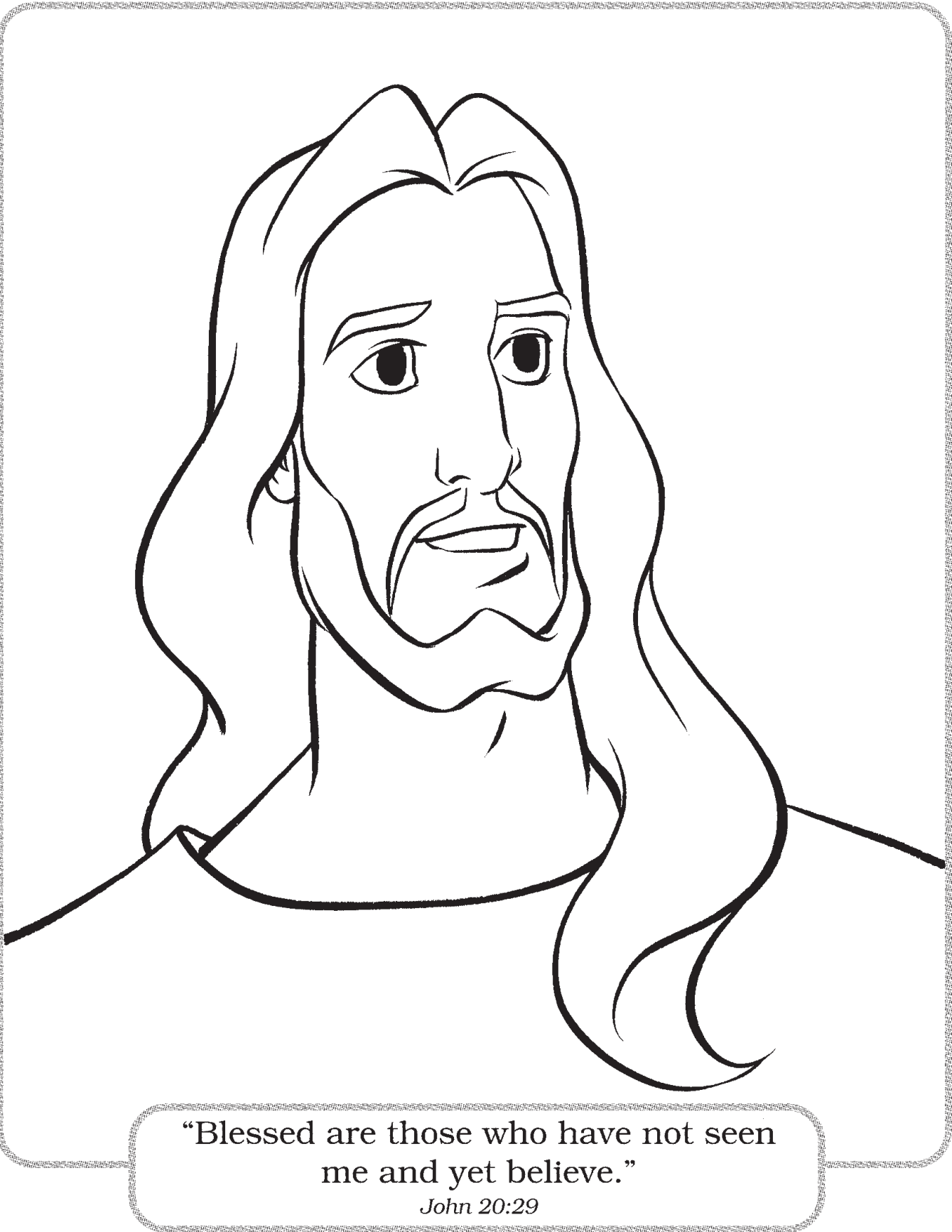

“Blessed are those who have not seen  
me and yet believe.”

*John 20:29*

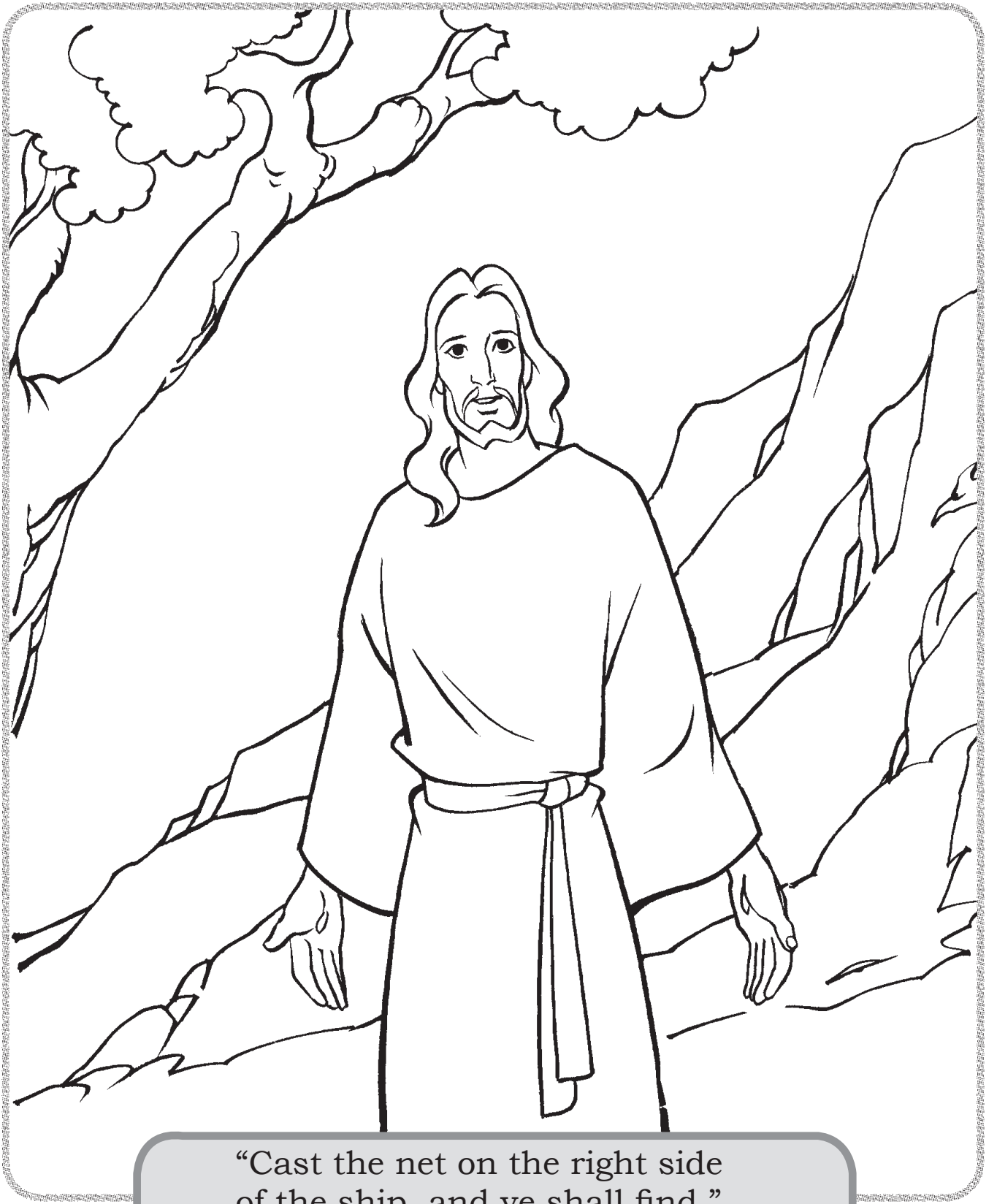

“Cast the net on the right side  
of the ship, and ye shall find.”

*John 21:4-6*



# Find the Fish

Help Peter find ten fish. Circle each fish and color the picture.

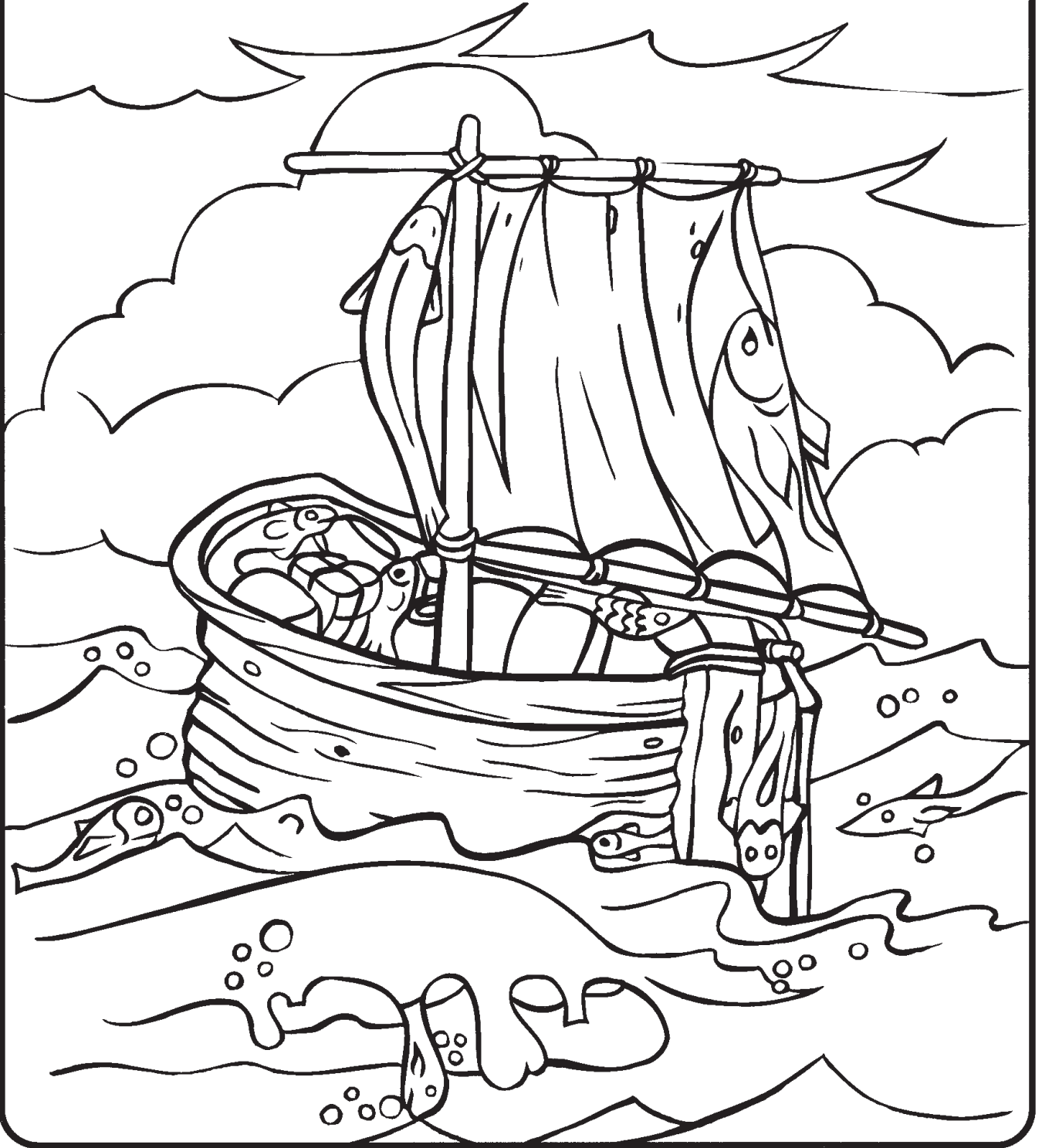





**Jesus talks to Simon Peter.**

*John 21:15-19*

# Does it Belong?

Circle the things that belong to the story about Jesus. You may color all of the pictures.

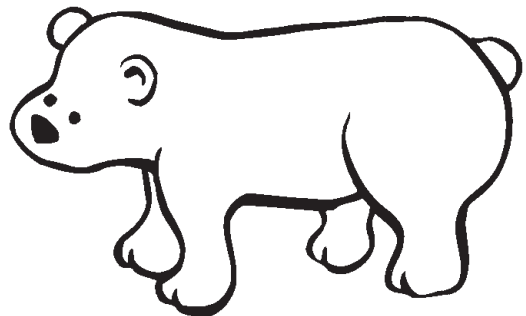
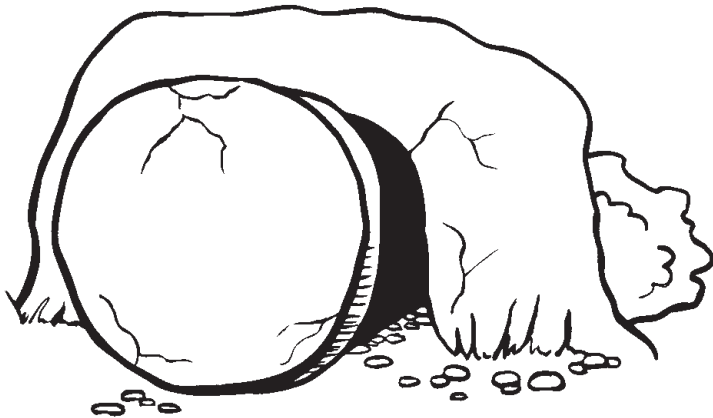
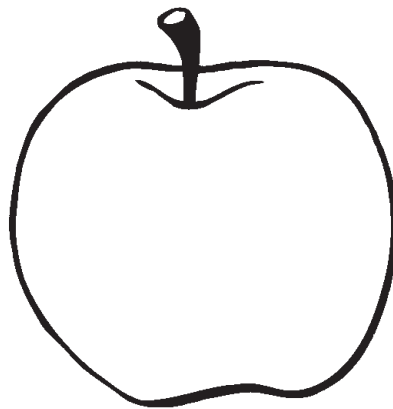
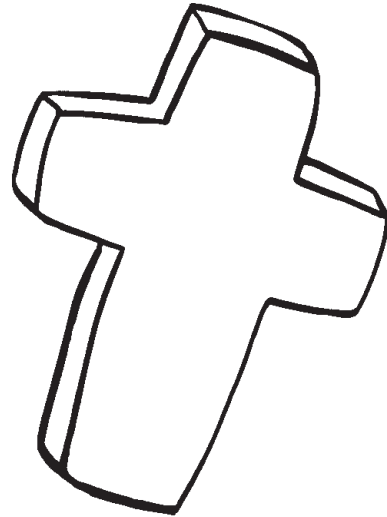



**“This same Jesus which is taken from  
you into heaven shall come again.”**

*Acts 1:11*





# Level Two

 **NEST Family Entertainment™**



# TABLE of CONTENTS

Teacher or Parent Guide .....	2
Activities & Color Pages:	
Word Search .....	5
Color Page - The earth quakes... ..	6
Picture Writing .....	7
Word Whirls .....	8
Color Page - Joseph of Arimathaea... ..	9
The Hidden Word .....	10
Word Search .....	11
Color Page - The centurions guard... ..	12
The A-maze-ing Resurrection .....	13
Letter Swap .....	14
Word Jumble .....	15
Find the Words .....	16
Crossword .....	17
Color Page - The women find... ..	18
Who Am I? .....	19
Time to Rhyme .....	20
Word Wheel .....	21
Word Maze .....	22
Color Page - Jesus goes up to heaven... ..	23
Take an *S.A.T. ....	24
Points to Ponder .....	25
Level Two Answer Key .....	A3-A4
Scriptural References .....	B1-B3
Level Two Certificate of Achievement .....	C2





# WORD SEARCH



Find these hidden words and circle them in the puzzle below.  
Hint: Some words read across. Some read up and down.

- |        |        |           |
|--------|--------|-----------|
| Jesus  | Pilate | Caiaphas  |
| Peter  | Angel  | Thomas    |
| Hope   | Mary   | Nicodemus |
| ✓ Tomb | Heaven | John      |



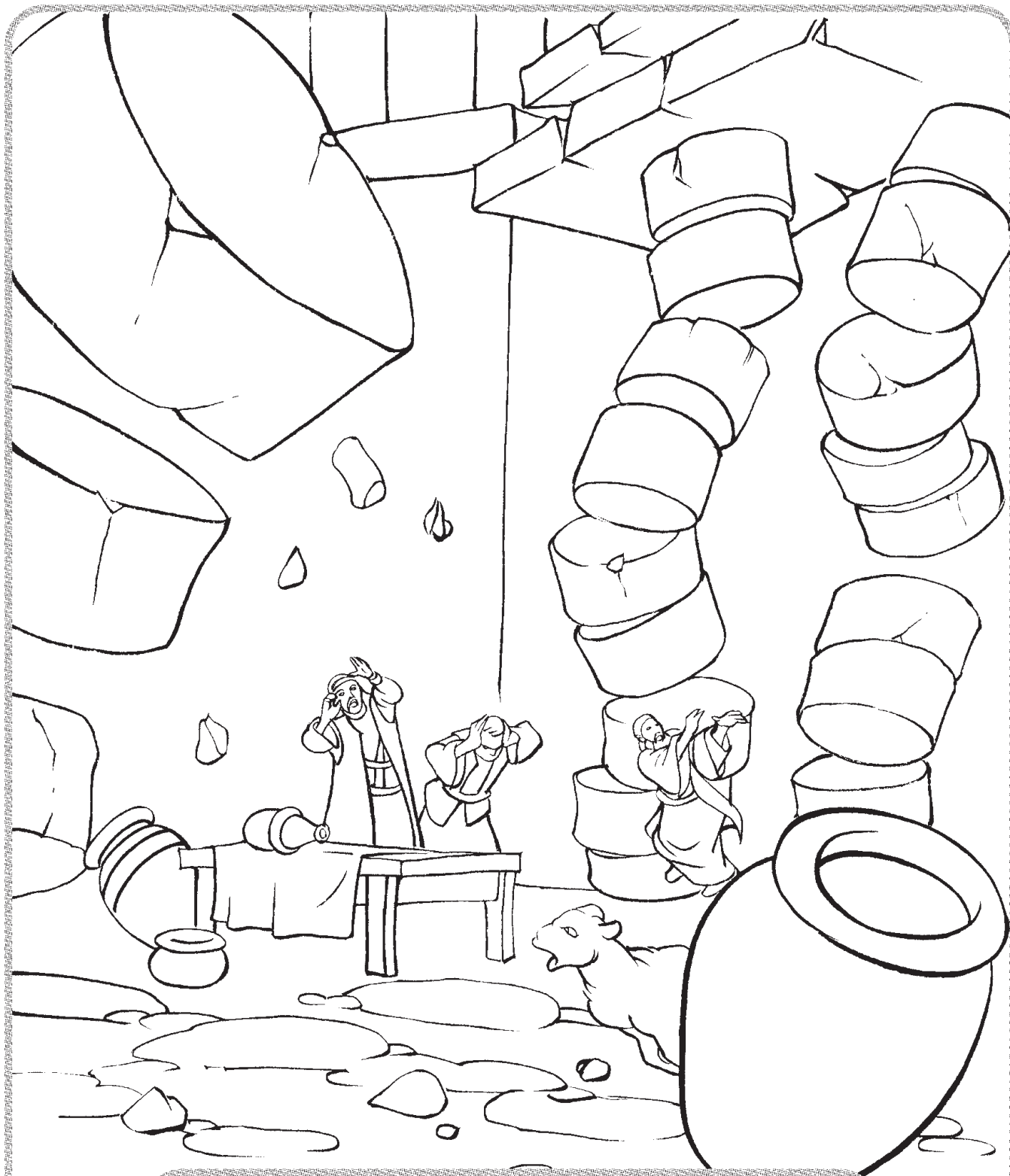

The earth quakes when Jesus dies.

*Matthew 27:51*

# PICTURE WRITING

Jesus told his disciples that something would happen after he was crucified. Translate the message below to find what Jesus told them.

To solve the code, find the letter for each picture in the Code Box and write the letter in the blank below the picture.

## CODE BOX

A	B	C	D	E	F	G	H	I
J	K	L	M	N	O	P	Q	R
S	T	U	V	W	X	Y	Z	

_____	_____	_____	_____	_____	_____	_____	_____	_____	_____
_____	_____	_____	_____	_____	_____	_____	_____	_____	_____

To find the answer in your Bible, turn to Luke 24:7.

# Word Whirls

Solve the word whirls below to learn some words used to describe places and names in Jesus' time.

On each word whirl below, begin at the arrow and circle the first letter. Then circle every other letter. The circled letters will make a word that will answer the question below each puzzle. Write your answers in the blanks.



1. What is the Hebrew name for the place where Jesus was crucified?

---

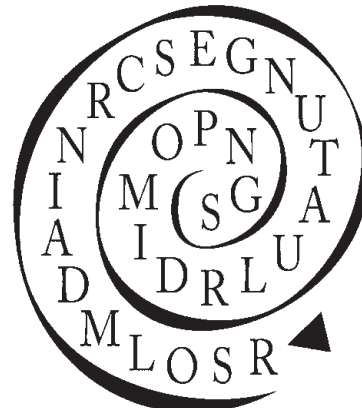

2. What were Pilate's soldiers called? (2 words)

---



3. What is the name for the group of religious leaders that wanted Jesus killed? (2 words)

---

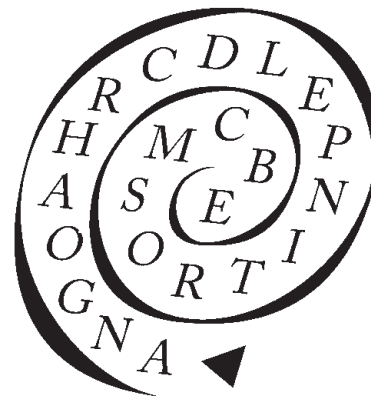

4. Where was Jesus buried? (3 words)

---

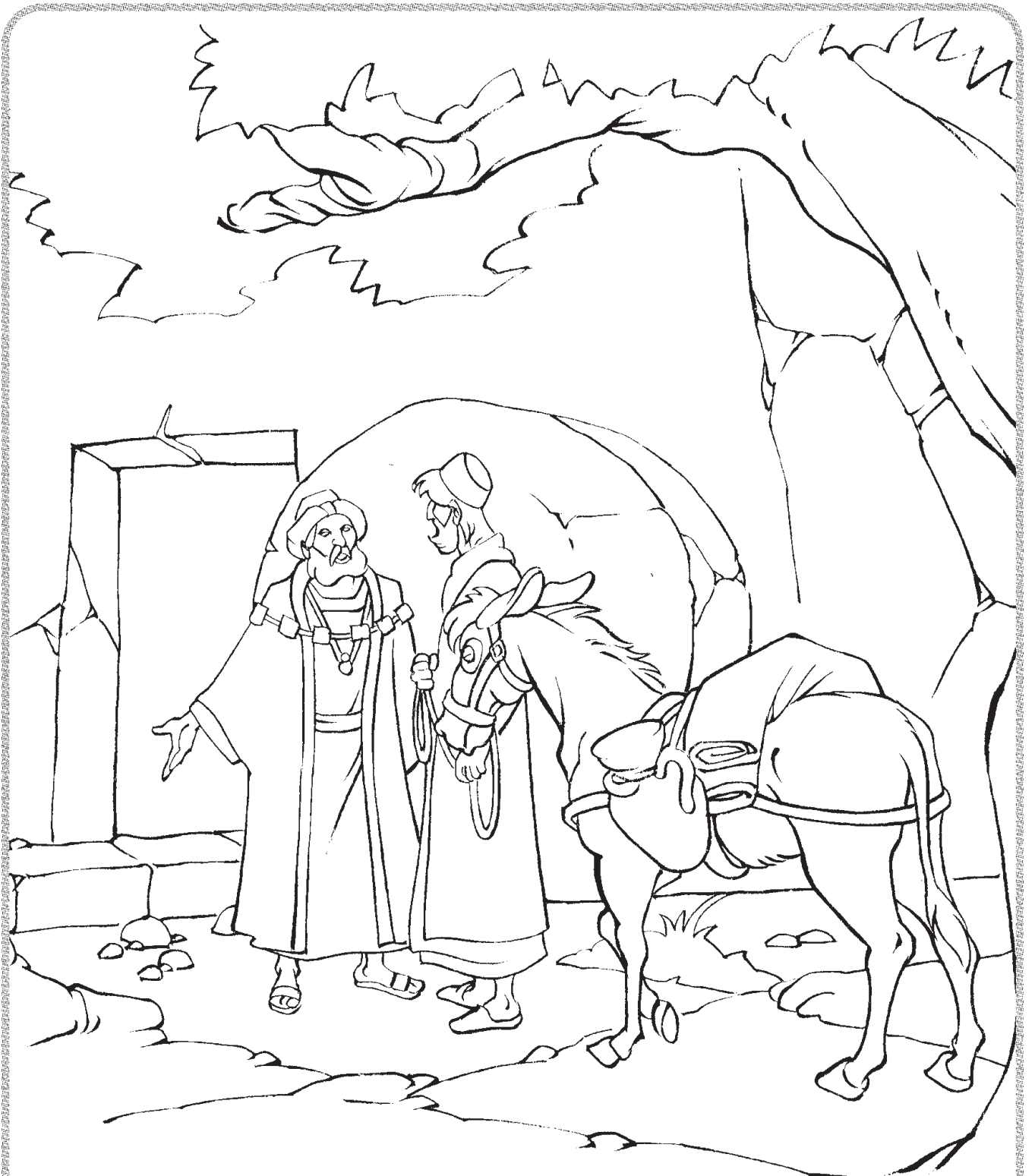

Joseph of Arimathaea and Nicodemus  
put the body of Jesus in the tomb.

*John 19:38-42*



# The Hidden Word

## The Hidden Word

A word is hidden in the puzzle below. To find the word: 1) circle the number of each true statement listed below and 2) find the circled numbers on the puzzle below and color in only these numbered spaces.

1. There was an earthquake when Jesus died.
2. The disciples were sad at Jesus' death.
3. Caiaphas asked for Jesus' body.
4. Nicodemus and Joseph of Arimathaea put Jesus' body in the tomb.
5. Caiaphas was pleased with Pilate.
6. Roman centurions guarded Jesus' tomb.
7. The women brought food for the disciples.
8. All of the disciples believed that Jesus had risen.
9. Mary Magdalene thought Jesus was the gardener.
10. Jesus appeared to his disciples only once after he had risen.

3 1	2	5 4	5	1	7 8	7	3	8 4	6	2	10	2	6	1	8	1	3	5
6	8	7	3	2	9 5	2	5	7	8	5	3	7	3	5	10	2	8	10
9	1	2	10	4	1 3	4	8	1	10 4	6	5	4	9	8	3	4	3	5
4	5	7	8	6	3 9	6	10	9	3	7	8	6	5	10	3	6	8	10
9	10	6	5	7	10 2	9	3	5 1	2	9	10	2	4	1	5	7	9	1

Who rolled away the stone to the tomb and told the women that Jesus had risen?

Fill in the "hidden word" here: \_\_\_\_\_.

# WORD SEARCH



Find and circle all of the words that are hidden in the puzzle below. Words are down, across, diagonal, and backwards. You will find a list of these words in the word box at the bottom of the page.



**F E M A N E T S T B C G H P F Z**  
**E C A E E D C R R L E T A L I P**  
**U I R A E Y D I S C I P L E S X**  
**W F Y H X K B U E J Z W T S H O**  
**V I N T B E A N O I N T F N E Z**  
**T R L A V B N U I K O N S O R S**  
**S C A M T X G N Q A Z E R I M Y**  
**R A U I F N E W O H C E G R E F**  
**Q S B R N I L V P I T N Z U N I**  
**O E S A E C S N P E S R A T T C**  
**N C P F X O B S P J O N A N Q U**  
**P A B O U D M N Z H N E E E Y R**  
**M I Q H H E O Q T B K V I C N C**  
**L A N P B M T G O V X A H J S T**  
**F P W E I U O J S U S E J G D A**  
**A H V S O S Q U Z N B H N I Z L**  
**C A D O U B T I N G T H O M A S**  
**D S X J N O I T C E R R U S E R**

## WORD BOX

- |               |                |               |                  |
|---------------|----------------|---------------|------------------|
| 1. ANGELS     | 7. CRUCIFY     | 13. HOPE      | 19. PILATE       |
| ✓ 2. ANOINT   | 8. DISCIPLES   | 14. JESUS     | 20. RESURRECTION |
| 3. ASCENSION  | 9. DOUBTING    | 15. JOSEPH OF | 21. SACRIFICE    |
| 4. BRIBE      | THOMAS         | ARIMATHAEA    | 22. SIMON PETER  |
| 5. CAIAPHAS   | 10. EARTHQUAKE | 16. MARY      | 23. SPICES       |
| 6. CENTURIONS | 11. FISHERMAN  | 17. NETS      | 24. TOMB         |
|               | 12. HEAVEN     | 18. NICODEMUS |                  |



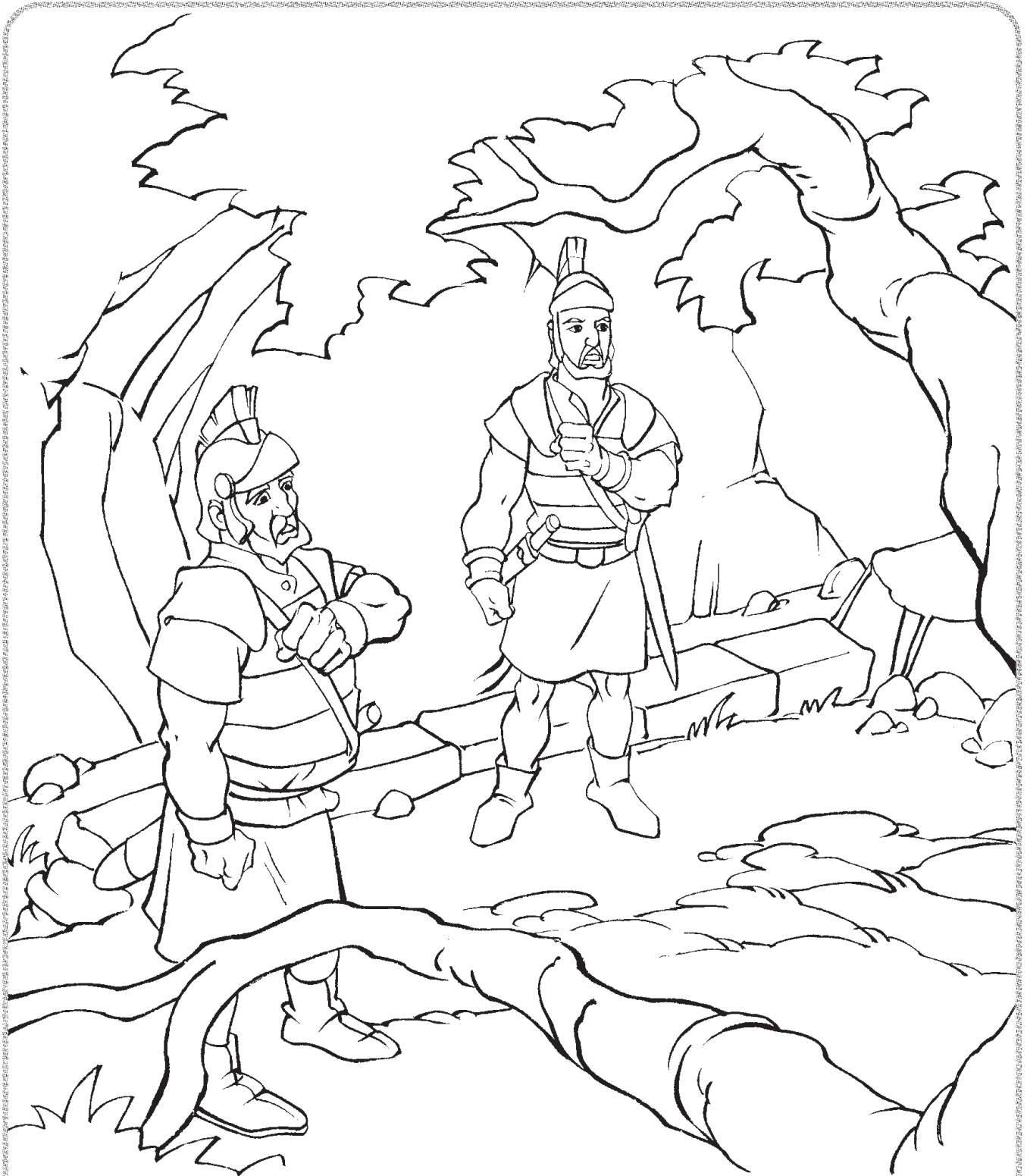

The centurions guard the tomb.

*Matthew 27:62-66*







# RESURRECTION



## WORD JUMBLE

Who am I? Unscramble each name on the right using the clues given in each statement on the left. Your answers will be names of people who were important in the story of Jesus' resurrection.

1. I had Jesus killed to try to keep the peace. Who am I? **I T L A P E**  
\_\_\_\_\_
2. When I saw Jesus die, I knew he was an innocent man. Who am I? **O R N C I T U N E**  
\_\_\_\_\_
3. I asked for Jesus' body so I could bury it before the Sabbath. Who am I? **P O J E S H**  
\_\_\_\_\_
4. I wanted Pilate to post guards at Jesus' tomb. Who am I? **A C A S H A P I**  
\_\_\_\_\_
5. I was resurrected on the third day. Who am I? **E S S U J**  
\_\_\_\_\_
6. I was crying in the garden by the empty tomb. Who am I? **R A Y M**  
\_\_\_\_\_
7. I ran to the tomb with John to see if Jesus' body was gone. Who am I? **E T P R E**  
\_\_\_\_\_
8. I did not believe Jesus was alive until I saw him. Who am I? **S T A H O M**  
\_\_\_\_\_

# FIND THE WORDS

Follow each step below to find why Jesus was willing to die on the cross.

1. Cross off every letter that rhymes with "see."

B	I	D	E	G	V	T	C
E	C	T	O	P	D	E	G
D	G	V	T	C	S	B	Z
U	B	C	E	N	G	V	D
P	E	T	G	Z	C	R	B
C	D	S	B	E	D	E	G

2. Write the remaining letters in the boxes:

--	--	--	--	--	--	--	--

For an extra challenge try timing yourself!



3. Unscramble the letters to form two words in the boxes below that explain why Jesus died on the cross.

Jesus died on the cross to forgive...

--	--	--

--	--	--	--

# CROSSWORD

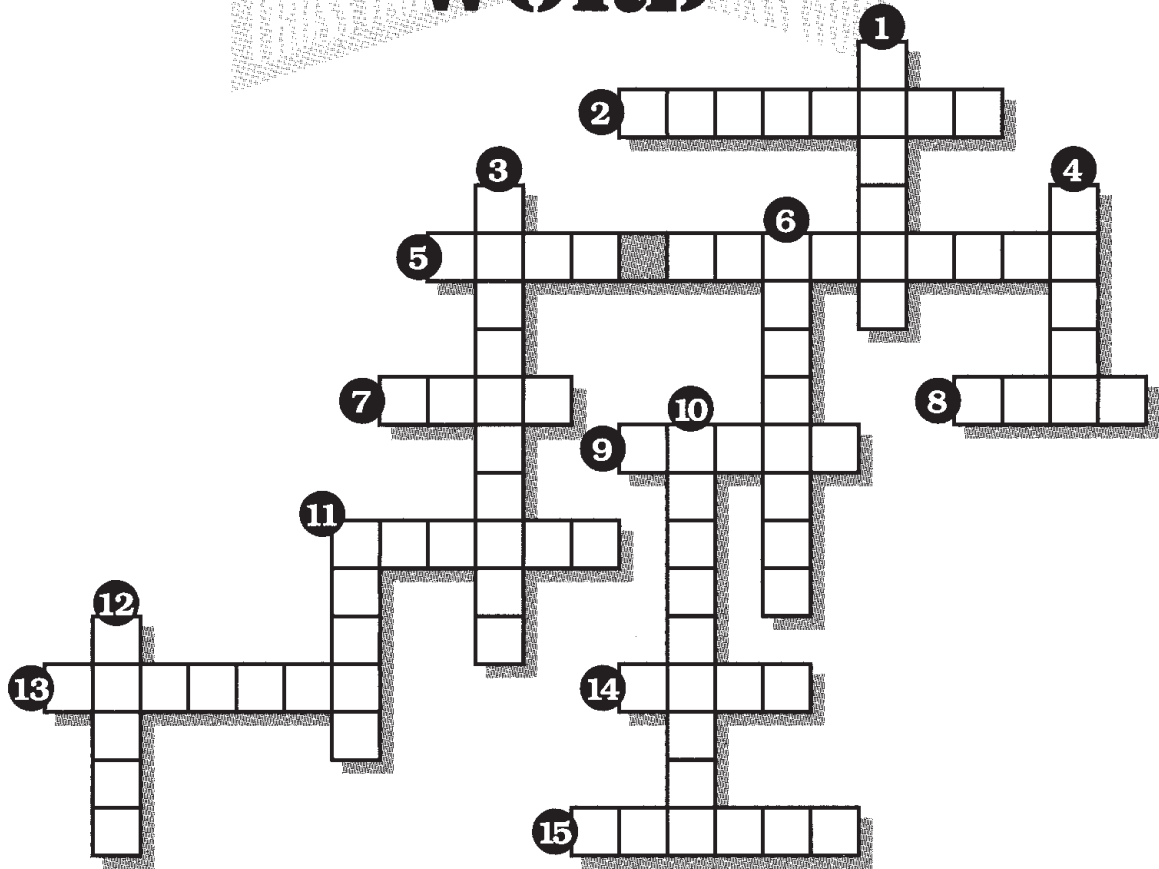

## ACROSS

2. He bribed the centurions to lie about Jesus' body.
5. She wept outside the tomb. (2 words)
7. He was one of the disciples who ran to the tomb when he heard Jesus had risen.
8. Jesus said that he would \_\_\_\_\_ on the third day.
9. He told the women at the tomb that Jesus had risen.
11. He placed guards at the tomb.
13. The disciples did not \_\_\_\_\_ that Jesus had risen.
14. This ripped in two when Jesus died.
15. \_\_\_\_\_ of Arimathaea buried Jesus' body in his tomb.

## DOWN

1. He doubted Jesus was alive even after others had seen him.
3. This calamity happened at the time of Jesus' death.
4. He died and rose again on the third day.
6. At the tomb Mary Magdalene thought Jesus was the \_\_\_\_\_.
10. He brought spices to the tomb to anoint Jesus' body.
11. He denied Jesus three times.
12. Jesus said, "\_\_\_\_\_ be unto you."

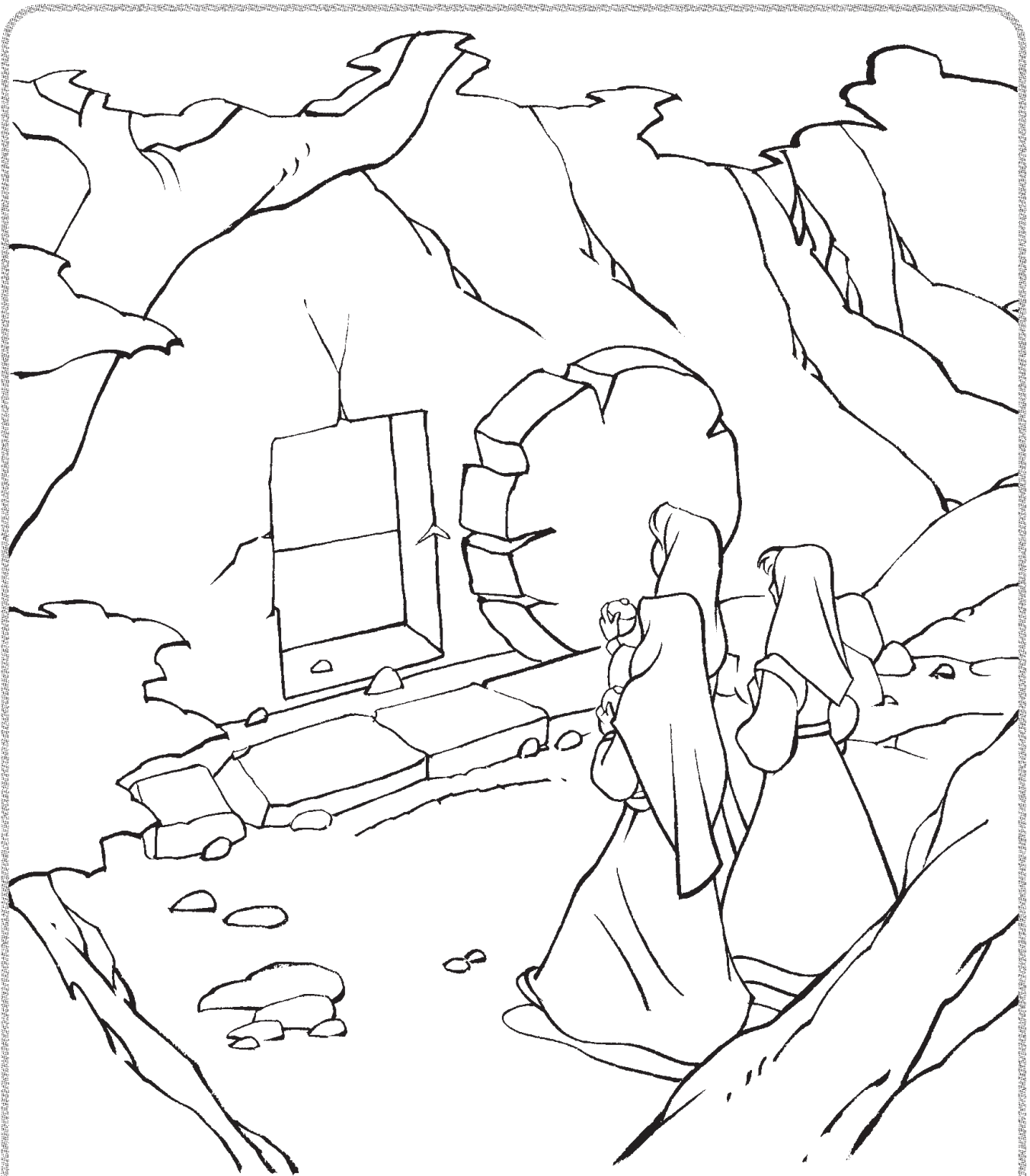

The women find the tomb empty.

*Mark 16:1-6; Luke 24:1-3; John 20:1-2*

# WHO AM I ?



Each rhyme describes a person or thing from the story of the resurrection of Jesus. Read each rhyme aloud. Then write your answer in the blank.

**I had orders from my boss  
To watch Jesus on the cross.  
Jesus cried out, "It is done,"  
And I knew he was God's Son.**

**WHO AM I ?**

---

**I occurred when Jesus died;  
Rocks were broken, earth split wide.  
Soldiers fell down on their knees  
Shaking like the ground and trees.**

**WHAT AM I ?**

---

**I was crying all alone  
In the garden by the stone.  
Unexpectedly Christ came,  
And he softly called my name.**

**WHO AM I ?**

---

**An angel with a glowing face  
Rolled me from my proper place  
Leaving open Jesus' tomb.  
I had sealed the burial room.**

**WHAT AM I ?**

---

**I denied my Lord three times,  
Which is worse than any crime.  
But he still forgave my sin,  
Letting me begin again.**

**WHO AM I ?**

---

**I was used all through the night,  
But I did not catch a bite.  
Then the last time in the lake  
I was filled and began to break.**

**WHAT AM I ?**

---





# TIME TO RHYME

Now it is your turn to think of a rhyme.  
There's nothing much to it, just give yourself time.  
Look for the UNDERLINED words in this game,  
Then find other words that sound almost the same.

The disciples knew he SAID \_\_\_\_\_  
That he would rise from the \_\_\_\_\_  
Still it came as a surPRISE; \_\_\_\_\_  
They could not believe their \_\_\_\_\_



What a spectacle they MADE. \_\_\_\_\_  
Trembling and so A- \_\_\_\_\_  
They thought Jesus was a GHOST; \_\_\_\_\_  
Seeing him would startle \_\_\_\_\_

He said, "Peace be unto YOU," \_\_\_\_\_  
And they knew that it was \_\_\_\_\_  
The disciples touched him THEN. \_\_\_\_\_  
Jesus was alive A- \_\_\_\_\_

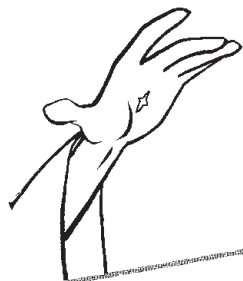

On his hands in shapes like STARS, \_\_\_\_\_  
Were the marks of the nail \_\_\_\_\_  
But the suffering was PAST; \_\_\_\_\_  
Jesus' work was done at \_\_\_\_\_







# WORD MAZE

Jesus died and rose again. He became the way for us to have eternal life. Solve the puzzle to find what Jesus said.

**STEP 1:** Start with the square in the upper left-hand corner. Draw a line connecting all the shapes that have exactly four sides. You can only move one square at a time.

**START HERE** →

I	COM-	BLESS	HERE	LIFE
ING	AM	ANCE	THE	IN
RISE	THE	PEAR-	WHEN	AND
RE-	FOR	AP-	TION	IF
BUT	SUR-	REC-	FIRST	GO

**STEP 2:** On the line below, write the words from inside the shapes that you connected. Join the hyphenated syllables to make one word.

Jesus said, “ \_\_\_\_\_ ”.

To find the answer in your Bible, read John 11:25.

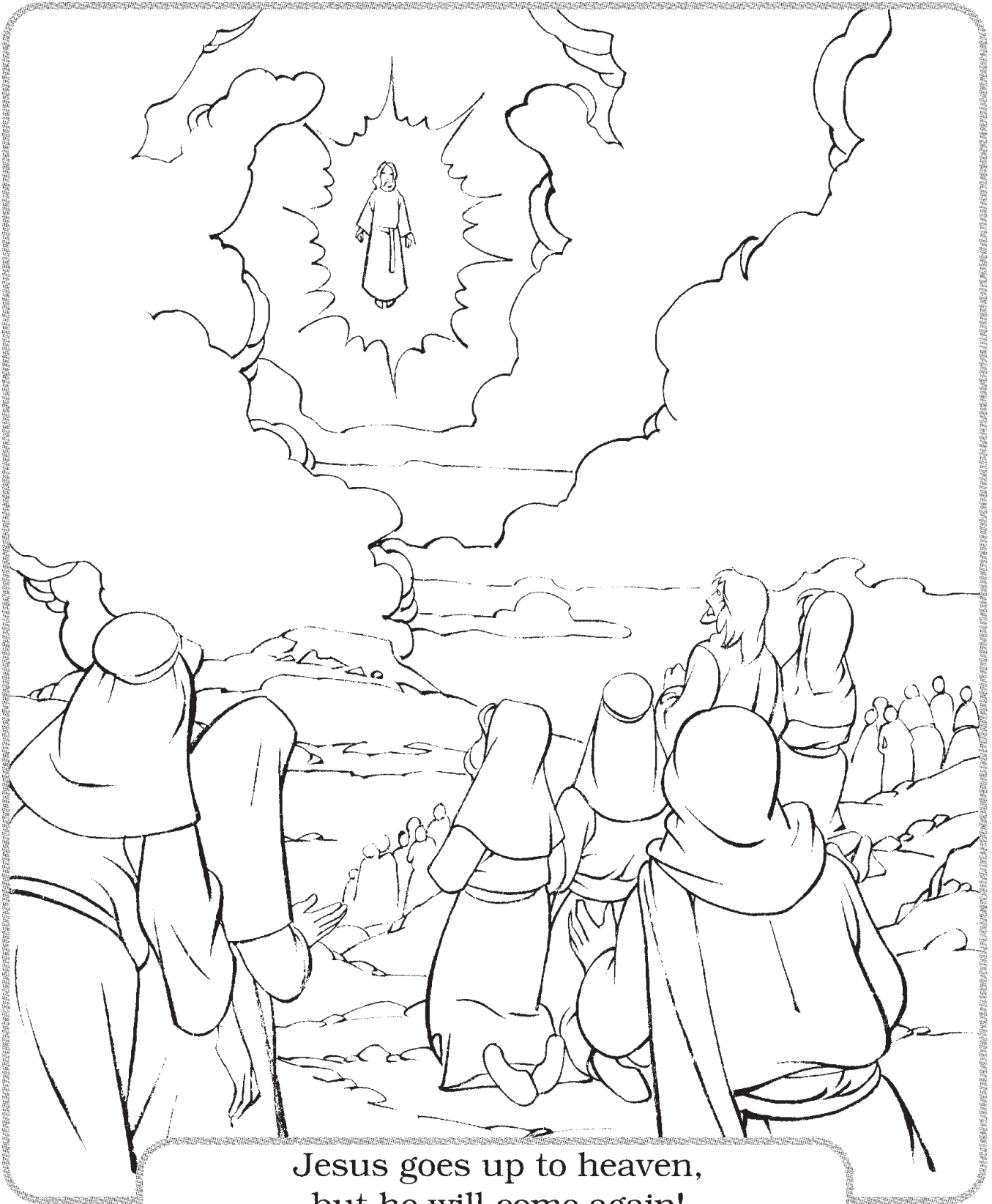

**Jesus goes up to heaven,  
but he will come again!**

*Mark 16:19; Luke 24:51; Acts 1:10-11*



# Take an \*S.A.T. \*Scripture Awareness Test



- 1) What natural disaster occurred in Jerusalem when Jesus died?  
\_\_\_\_\_
- 2) Where were the disciples when Jesus died?  
\_\_\_\_\_
- 3) Who was Joseph of Arimathaea?  
\_\_\_\_\_
- 4) What did Caiaphas ask Pilate to do?  
\_\_\_\_\_
- 5) What were the women taking to the tomb on the third day?  
\_\_\_\_\_
- 6) What did Peter and John think had happened to Jesus' body?  
\_\_\_\_\_
- 7) Who was the first person to see Jesus after he was resurrected?  
\_\_\_\_\_
- 8) Who bribed the guards to say they were asleep when Jesus' body disappeared?  
\_\_\_\_\_
- 9) Which disciple was not present when Jesus appeared to his followers the first time?  
\_\_\_\_\_
- 10) What miracle happened when the disciples threw their nets on the other side of the boat?  
\_\_\_\_\_
- 11) What did the angel say to the disciples after Jesus ascended to heaven?  
\_\_\_\_\_

# HE IS RISEN



## POINTS TO PONDER

1. **W**hy did Jesus die on a cross instead of using his power to save himself?

2. **W**hat is faith?  
(Clue: Look up Hebrews 11:1 to get some help.)

3. **J**esus said, "Blessed are those who have not seen me, and yet believe." What are three things we believe by faith?

4. **W**hat did Jesus mean when he said to Peter, "Feed my lambs"?

5. **J**esus' last instructions to his disciples were that they tell other people about him. What are some ways we can spread the good news about Jesus even today?

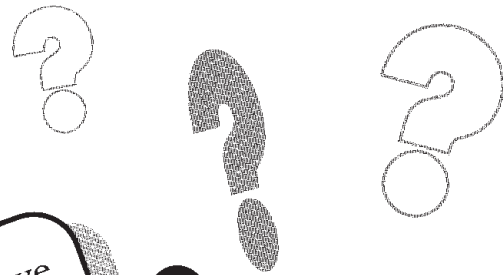

# ANSWER KEY

## LEVEL ONE

### MATCH THE SHAPES — PAGE 6

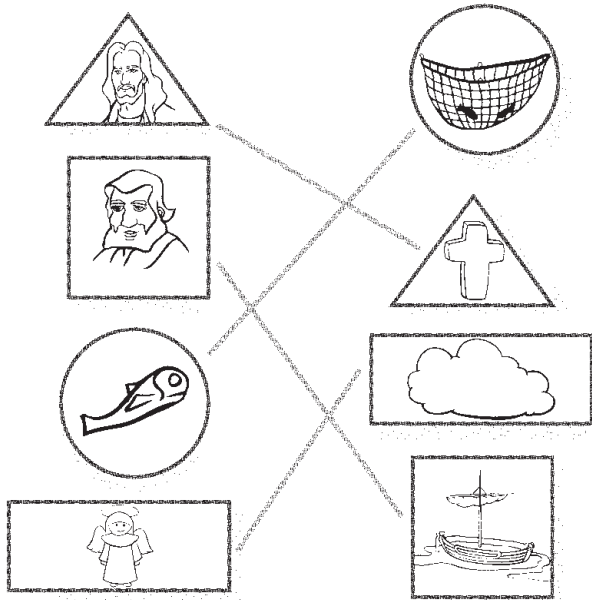

### COLOR THE SHAPES — PAGE 11

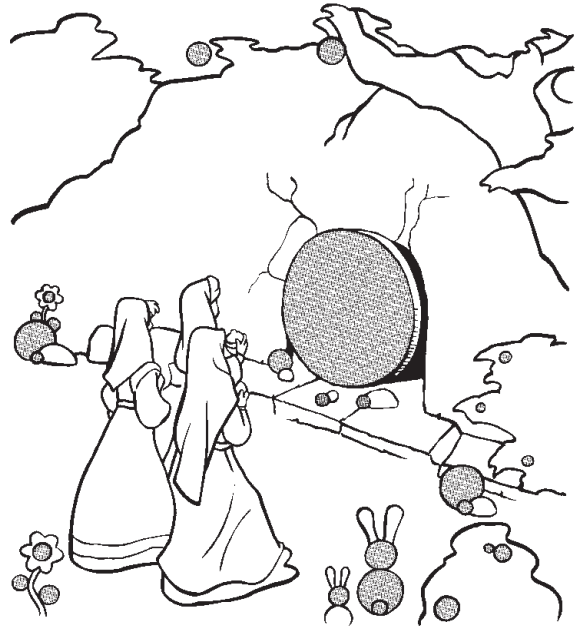

### DOT TO DOT — PAGE 9

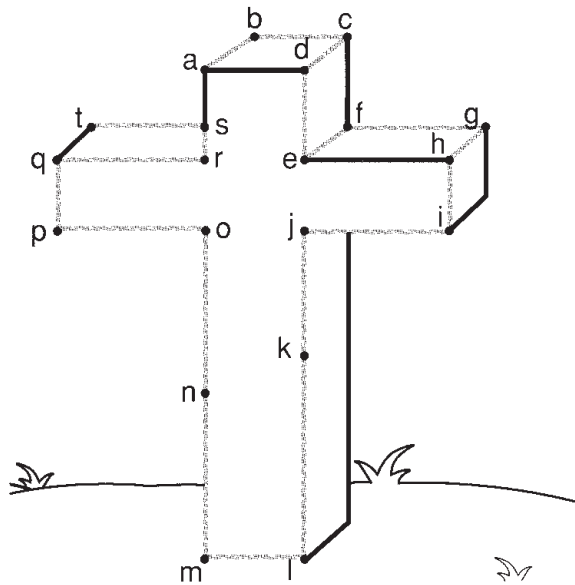

### WORD PUZZLE — PAGE 13

b	o	a	t	g
f	i	s	h	o
c	o	o	k	o
n	e	t	o	d
e	e	a	t	o

# ANSWER KEY

## LEVEL ONE

### THE EMPTY TOMB — PAGE 15

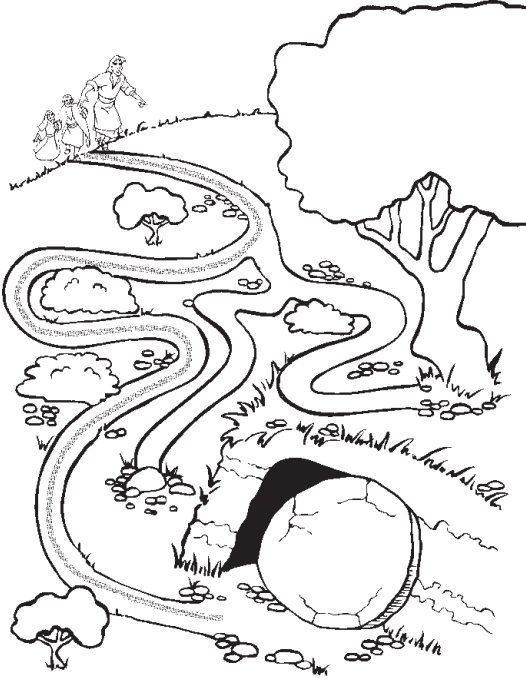

### FIND THE FISH — PAGE 22

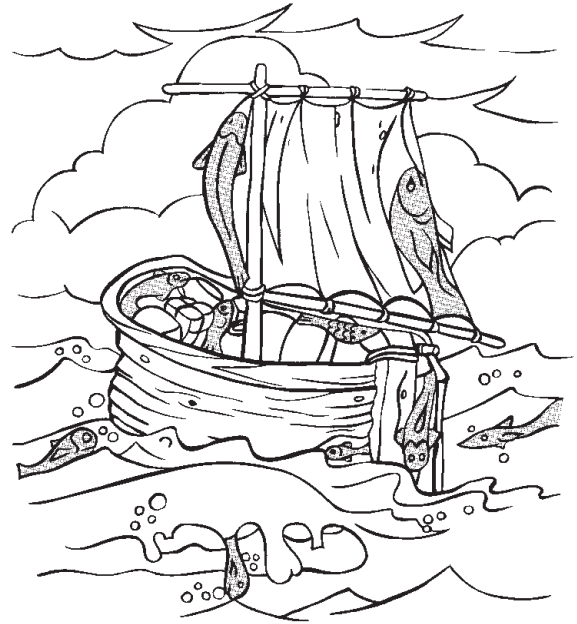

### FIND THE WORDS — PAGE 17

STEP 1: ~~A~~J~~E~~A~~S~~S~~U~~S

STEP 2: ~~B~~D~~I~~~~B~~E~~D~~~~E~~

STEP 3: ~~C~~F~~O~~~~O~~~~C~~R~~O~~

STEP 4: ~~D~~D~~M~~~~D~~E~~D~~

*Jesus died for me!*

### DOES IT BELONG? — PAGE 24

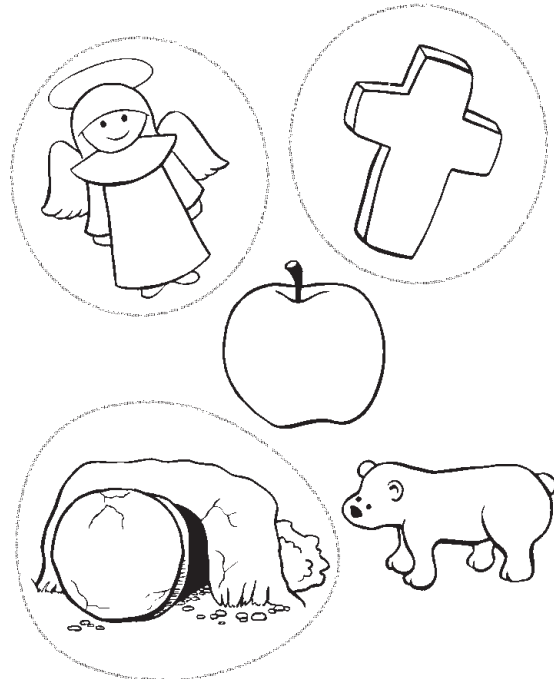



# ANSWER KEY

## LEVEL TWO

### WORD SEARCH — PAGE 5



### PICTURE WRITING — PAGE 7

Answer: He would rise the third day.

### WORD WHIRLS — PAGE 8

1. Golgotha

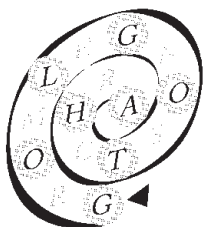

2. Roman centurions

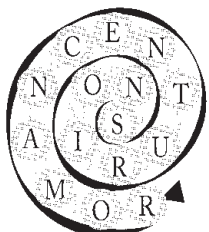

3. The Sanhedrin

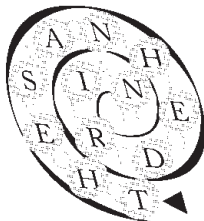

4. A garden tomb

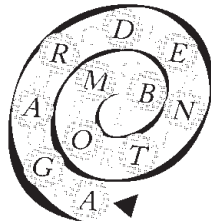

### THE HIDDEN WORD — PAGE 10

True Statements: 1, 2, 4, 6, 7, 9

Answer: Angel

3	1	2	4	5	1	8	7	3	8	4	6	2	10	2	6	1	8	1	3	5
6	8	7	3	2	9	5	2	5	7	8	5	3	7	3	5	10	2	8	10	
9	1	2	10	4	1	4	8	1	10	4	6	5	4	9	8	3	4	3	5	
4	5	7	8	6	3	9	6	10	9	3	7	8	6	5	10	3	6	8	10	
9	10	6	5	7	10	9	3	5	1	2	9	10	2	4	1	5	7	9	1	

### WORD SEARCH — PAGE 11



### THE A-MAZE-ING RESURRECTION — PAGE 13

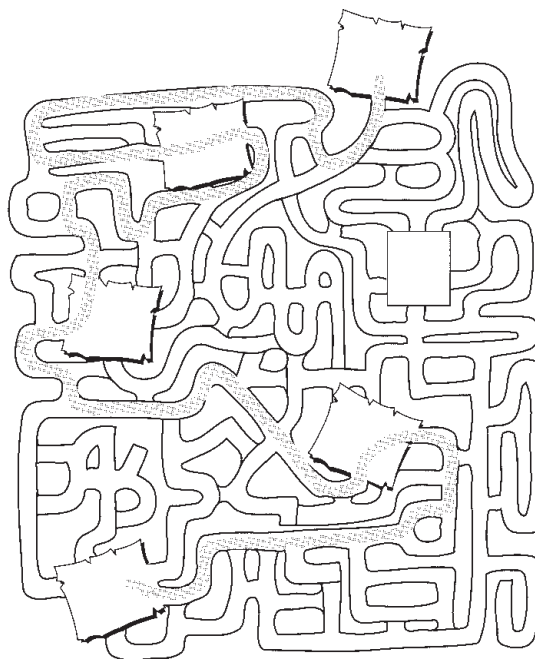



# ANSWER KEY

## LEVEL TWO

### LETTER SWAP — PAGE 14

SHI SORINERCRUTE

Answer: His Resurrection

### TIME TO RHYME — PAGE 20

dead          afraid          true          scars  
eyes          most          again          last

### WORD JUMBLE — PAGE 15

1. Pilate
2. Centurion
3. Joseph
4. Caiaphas
5. Jesus
6. Mary
7. Peter
8. Thomas

### FIND THE WORDS — PAGE 16

Answer: Our sins

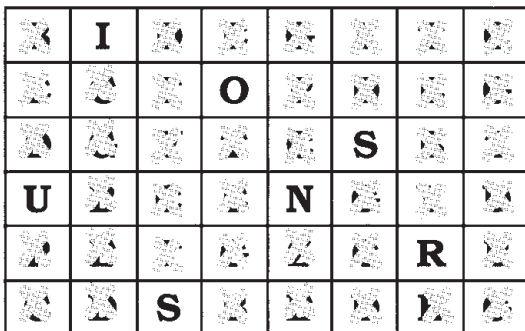

### CROSSWORD — PAGE 17

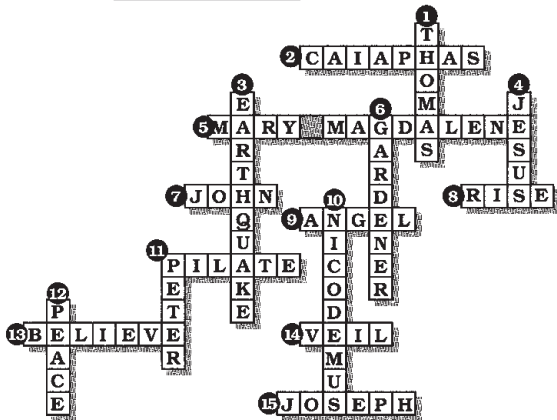

### WHO AM I? — PAGE 19

Answers:

a centurion          earthquake  
Mary                  stone  
Peter                  fishing net

### WORD WHEEL — PAGE 21

Answer: He ascended into heaven.

### WORD MAZE — PAGE 22

Answer: "I am the resurrection and the life."

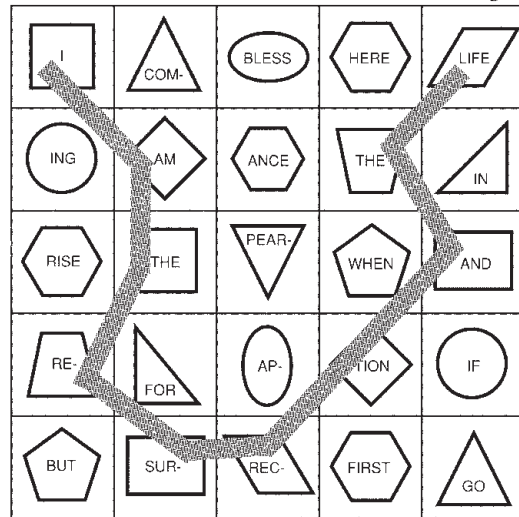

### TAKE AN \*S.A.T. — PAGE 24

1. An earthquake occurred.
2. They were hiding at a house in the city.
3. He was the man who asked Pilate for Jesus' body.
4. He asked Pilate to place guards at the tomb.
5. They were taking spices and ointments.
6. They thought it had been stolen.
7. The first person to see Jesus was Mary Magdalene.
8. The chief priests bribed the guards.
9. Thomas was not in the room.
10. They caught so many fish that they could not pull in their nets.
11. The angel said Jesus would come again.

# SCRIPTURE REFERENCES

Angel, Appearance Of, At Resurrection	Matthew 28:2		
Angels, Appearance Of, At Jesus' Ascension	Acts 1:9-11		
Anointing Of Jesus' Body	John 19:39-40		
Apostles, Unbelief Of, In Resurrection	Luke 24:9-11		
Appearance Of Angel At Resurrection	Matthew 28:2		
Appearance Of Angel To Women	Matthew 28:5-7		
Appearance Of Angels At Jesus' Ascension	Acts 1:9-11		
Appearance Of Jesus To Disciples While Fishing	John 21:3-7		
Appearance Of Jesus To Disciples	John 20:19-23		
Appearance Of Jesus To Doubting Thomas	John 20:24-29		
Appearance Of Jesus To Mary	Mark 16:9	John 20:14-17	
Ascension Of Jesus Christ	Mark 16:19	Luke 24:50-51	Acts 1:9-11
Belief Of Centurion That Jesus Is Son Of God	Matthew 27:54	Mark 15:39	
Body Of Jesus Given To Joseph Of Arimathaea	Matthew 27:57-58	Mark 15:43-45	John 19:38
Body Of Jesus Laid In Sepulcher	Matthew 27:60	Mark 15:46	Luke 23:53
Bribing Of Centurions By Caiaphas	Matthew 28:11-15		
Burial Of Jesus	Matthew 27:59-60	Mark 15:46	Luke 23:53
Caiaphas Bribes Centurions To Lie	Matthew 28:11-15		
Caiaphas Requests Guards At Jesus' Tomb	Matthew 27:62-66		
Casting Of Nets On Right Side Of Ship	John 21:5-6		
Catching Of Fish By Disciples With Jesus' Help	John 21:5-6		
Centurion Believes Jesus Is Son Of God	Matthew 27:54	Mark 15:39	
Centurions Bribed By Caiaphas To Lie	Matthew 28:11-15		
Centurions Falling As Dead At Resurrection	Matthew 28:4		
Christ (see Jesus)			
Cloth, Linen, Jesus' Body Wrapped In	Matthew 27:59	Mark 15:46	Luke 23:53
Coming Of Jesus, Second, Promise Of	Acts 1:11		
Crucifixion Of Jesus	Matthew 27:32-50	Mark 15:21-37	Luke 23:33-46
Crying Of Mary At Sepulcher	John 20:11		
Dead, Centurions Falling As, At Resurrection	Matthew 28:4		
Dead, Jesus Rises From	Matthew 28:1-10	Mark 16:1-8	Luke 24:1-12
Death, Disciples Mourn At Jesus'	Mark 16:10		
Death Of Jesus	Matthew 27:45-50	Mark 15:33-37	Luke 23:44-46
Dining Of Jesus With Disciples After Resurrection	John 21:12-14		
Disciples, Appearance Of Jesus To	John 20:19-23		
Disciples Catch Fish With Jesus' Help	John 21:5-6		
Disciples Catch No Fish All Night	John 21:3-5		
Disciples Feel Prints Of Nails In Jesus	Luke 24:39-40		
Disciples, Jesus Appears To, While Fishing	John 21:3-6		
Disciples, Jesus Dines With, After Resurrection	John 21:12-14		
Disciples, Jesus Teaches	John 21:15-19		
Disciples Mourn At Jesus' Death	Mark 16:10		
Disciples Of Jesus Witness Ascension	Acts 1:9-11	Mark 16:19	Luke 24:50-51
Disciples Present At Jesus' Death	John 19:26-27	Luke 23:49	
Disciples, Unbelief Of, In Resurrection	Luke 24:10-11		
Doubting Thomas (see Thomas, Doubting)			
Earthquake At Death Of Jesus	Matthew 27:51		
Earthquake At Resurrection Of Jesus	Matthew 28:2		
Empty, Disciples Find Sepulcher	Luke 24:12	John 20:3-10	
Empty Tomb, Women Find	Matthew 28:1-7	Mark 16:1-7	Luke 24:1-7
Feed His Lambs, Jesus Tells Peter To	John 21:15		
Feed My Sheep, Jesus Tells Peter To	John 21:17		
Fish, Disciples Catch None All Night	John 21:3-5		
Fish, Disciples Catch With Jesus' Help	John 21:5-6		

# SCRIPTURE REFERENCES

Fishing, Jesus Appears To Disciples While	John 21:3-6		
Followers Of Jesus Witness Ascension	Acts 1:9-11	Mark 16:19	Luke 24:50-51
Followers Present At Jesus' Death	Matthew 27:55-56	Mark 15:40-41	Luke 23:49
Friend Of Jesus, Joseph Of Arimathaea	Matthew 27:57-58	Mark 15:43-45	John 19:38
Gardener, Mary Mistakes Jesus For	John 20:15		
God's Son, Centurion Believes That Jesus Is	Matthew 27:54	Mark 15:39	
Guards ( see Centurions)			
Guards Watch Over Jesus' Tomb	Matthew 27:62-66		
Jesus Appears To Disciples While Fishing	John 21:3-6		
Jesus Appears To Mary	Mark 16:9	John 20:14-17	
Jesus, Ascension Of	Mark 16:19	Luke 24:50-51	Acts 1:9-11
Jesus, Crucifixion Of	Matthew 27:32-44	Mark 15:21-32	Luke 23:26-43
Jesus, Death Of	Matthew 27:45-50	Mark 15:33-37	Luke 23:44-46
Jesus Dines With Disciples After Resurrection	John 21:12-14		
Jesus, Love Of Peter For	John 21:15-17		
Jesus Mistaken For Gardener by Mary	John 20:15		
Jesus, Peter Swims To	John 21:7		
Jesus, Quaking Of Earth At Resurrection Of	Matthew 28:2		
Jesus, Resurrection Of	Matthew 28:1-7	Mark 16:1-7	Luke 24:1-7
Jesus Teaches His Disciples	John 21:15-19		
Jesus Tells Peter To Feed His Lambs	John 21:15		
Jesus Tells Peter To Take Care Of His Sheep	John 21:16		
Jesus' Appearance To Disciples	John 20:19-23		
Jesus' Appearance To Doubting Thomas	John 20:24-29		
Jesus' Body, Anointing Of	John 19:39-40		
Jesus' Body Given To Joseph Of Arimathaea	Matthew 27:57-58	Mark 15:43-45	John 19:38
	Luke 23:50-52		
Jesus' Body Laid In Sepulcher	Matthew 27:60	Mark 15:46	Luke 23:53
Jesus' Body Wrapped In Linen Cloth	Matthew 27:59	Mark 15:46	Luke 23:53
Jesus' Death, Disciples Mourn At	Mark 16:10		
Jesus' Disciples Feel Prints Of Nails	Luke 24:39-40		
Jesus' Promise Of Coming Again	Acts 1:11		
Jesus' Resurrection, Thomas Doubts	John 20:25		
John, Running Of, To Sepulcher	John 20:2-4		
Joseph Of Arimathaea Anoints Jesus' Body	John 19:39-40		
Joseph Of Arimathaea Is Given Body Of Jesus	Matthew 27:57-58	Mark 15:43-45	John 19:38
Lambs, Jesus Tells Peter To Feed His	John 21:15		
Laying Of Jesus' Body In Sepulcher	Matthew 27:60	Mark 15:46	Luke 23:53
Lie, Centurions Bribed By Caiaphas To	Matthew 28:11-15		
Linen Cloth, Jesus' Body Wrapped In	Matthew 27:59	Mark 15:46	Luke 23:53
Love Of Peter For Jesus	John 21:15-17		
Mary, Crying Of, At Sepulcher	John 20:11		
Mary, Jesus Appears To	Mark 16:9	John 20:14	
Mary Mistakes Jesus For The Gardener	John 20:15		
Mary Present At Jesus' Death	Matthew 27:55-56	Mark 15:40	Luke 23:49
Mary Takes Spices To The Sepulcher	See Matthew 28:1	See Mark 16:1	Luke 24:1
Nails, Prints Of, Disciples Feel, In Jesus	Luke 24:39-40		
Nets, Casting Of, On Right Side Of Boat	John 21:5-6		
Nicodemus Anoints Jesus' Body	John 19:39-40		
Peter, Jesus Tells, To Feed His Sheep	John 21:17		
Peter, Love Of, For Jesus	John 21:15-17		
Peter Runs To Tomb With Others	Luke 24:12	John 20:3-4	
Peter Swims To Jesus	John 21:7		
Pilate Gives Jesus' Body To Joseph Of Arimathaea	Matthew 27:57-58	Mark 15-43-45	Luke 23:50-52
	John 19:38		



# Certificate of Achievement

This certifies that

\_\_\_\_\_ has mastered the

## He is Risen

RESOURCE & ACTIVITY BOOK

LEVEL ONE

from **NEST Family Entertainment™**

by successfully completing all of the puzzles, games, and activities found herein.

\_\_\_\_\_ As of this date

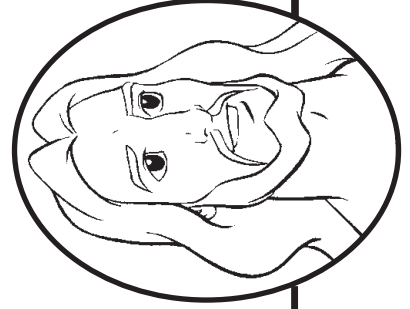

*NEST Family Entertainment*



# Certificate of Achievement

This certifies that

\_\_\_\_\_ has mastered the

## He is Risen

RESOURCE & ACTIVITY BOOK

LEVEL TWO

from **NEST Family Entertainment™**

by successfully completing all of the puzzles, games, and activities found herein.

\_\_\_\_\_ As of this date



*NEST Family Entertainment*

