

 **NEST Complete Learning System™**

**THE  
ANIMATED  
HERO  
CLASSICS®**

**Resource & Activity Book**



**Marco Polo**

By: M. G. Ron Johnson  
& Katherine Vawter

 **NEST Family Entertainment™**

# Parent and Teacher Guide

Studies have proven learning is enhanced through the use of several senses. A recent study shows that we retain 10 percent of what we see, 20 percent of what we hear, and 50 percent of what we see and hear. But when we see, hear and do, we retain 90 percent of the information.

(Lisa Marie Nelson, Ph.D., Author “The Healthy Family Handbook”).

The purpose of this Resource & Activity Book is to help children learn and retain the story theme and principles in a fun and educational way. Your children will love coloring pages, solving puzzles, matching games, completing word searches, and much more! Each Resource & Activity Book also features challenging questions and activities for children from preschool through middle school. And in the rare case you don't know an answer, there's an answer key in the back!

## LEVEL OF DIFFICULTY

The activities in this book are designed in three levels of difficulty designated by symbols. The activities with one symbol are geared towards younger children while the activities with two and three symbols become increasingly challenging for older children.



Level One  
Easy



Level Two  
Intermediate



Level Three  
Advanced

## CURRICULUM RELATED

These educational activities are related to various educational discipline such as social studies (geography, history, culture), language arts (spelling, creative writing, grammar, literature), math (simple equations), and science. There are also activities for character development, video awareness, problem solving, music, and art. The subject codes below are for your convenience.



Art



Character  
Development



Culture



Geography



History



Language  
Arts



Math



Music



Problem  
Solving



Science



Spelling



Video  
Awareness



Writing

## PERMISSION TO REPRODUCE

This Resource & Activity Book contains proprietary information, which is protected by copyright. All rights are reserved. However, any part of this book may be reproduced for personal or classroom use as long as it is not sold. Such permission does not include the storage of any part of this publication in a retrieval system or the transmission of such, in any form, or by any means, electronic, mechanical, recording, etc., without prior written permission of the publisher. This permission applies only to the printed material in this Resource & Activity Book and does not extend to any audio or video production released or distributed by NEST Family Entertainment™. For additional certificates or Resource & Activity Books, contact: NEST Family Entertainment™, LLC. 1461 S. Beltline Rd., Suite 500, Coppell, TX 75019.

# TABLE of CONTENTS

<b>Parent and Teacher Guide .....</b>	<b>2</b>	<i>Polo Press .....</i>	<i>24-25</i>
<b>References .....</b>	<b>4</b>	<i>Who Were They? .....</i>	<i>26</i>
<b>Activities &amp; Color Pages:</b>		<i>Color Page .....</i>	<i>27</i>
<i>Color Page .....</i>	<i>5</i>	<i>Match-Ups .....</i>	<i>28</i>
<i>How Did He Travel? .....</i>	<i>6</i>	<i>Word Scramble .....</i>	<i>29</i>
<i>Dot-to-Dot .....</i>	<i>7</i>	<i>Crossword Puzzle .....</i>	<i>30</i>
<i>Break the Code .....</i>	<i>8</i>	<i>Color Page .....</i>	<i>31</i>
<i>Color Page .....</i>	<i>9</i>	<i>Jot-It-Down Journal .....</i>	<i>32</i>
<i>Fly a Kite .....</i>	<i>10</i>	<i>Match the Continents .....</i>	<i>33</i>
<i>The Proverb .....</i>	<i>11</i>	<i>Mix 'n' Match Code .....</i>	<i>34</i>
<i>Treasure Hunt .....</i>	<i>12</i>	<i>Color Page .....</i>	<i>35</i>
<i>Color Page .....</i>	<i>13</i>	<i>Circle Maze .....</i>	<i>36</i>
<i>In So Many Words .....</i>	<i>14</i>	<i>Alphabetical Discoveries .....</i>	<i>37</i>
<i>Picture Puzzle .....</i>	<i>15</i>	<i>Map It .....</i>	<i>38</i>
<i>Color Page .....</i>	<i>16</i>	<i>Color Page .....</i>	<i>39</i>
<i>Time Line Scramble .....</i>	<i>17</i>	<i>True or False .....</i>	<i>40</i>
<i>Grid Code .....</i>	<i>18</i>	<i>Title Tag .....</i>	<i>41</i>
<i>Word Search .....</i>	<i>19</i>	<i>Questions .....</i>	<i>42</i>
<i>Color Page .....</i>	<i>20</i>	<i>Things to Think About &amp; Do .....</i>	<i>43</i>
<i>Origami .....</i>	<i>21</i>		
<i>Marco's Mission .....</i>	<i>22</i>	<b>Answer Key .....</b>	<b>44-46</b>
<i>Color Page .....</i>	<i>23</i>	<b>Certificate of Achievement .....</b>	<b>47</b>

# REFERENCES

For those wishing to further study the life of Marco Polo, some of the references used in research for the Resource & Activity Book are listed below, along with other titles that may be of interest.

The Encyclopedia of Discovery and Exploration. *The Glorious Age of Exploration*. Garden City, New York: Doubleday and Company, Inc., 1973.

Graves, Charles P. *A World Explorer, Marco Polo*. Champaign, Illinois: Garrard Publishing Company, 1963.

Greene, Carol. *Marco Polo, Voyager to the Orient*. Chicago: Children's Press, 1987.

Humble, Richards. *The Explorers*. Alexandria, Virginia: Time-Life Books, 1978.

Humble, Richards. *Marco Polo*. New York: G. P. Putnam's Sons, 1975.

Humble, Richards. *The Travels of Marco Polo*. New York: Franklin Watts, 1990.

Kent, Zachary. *The World's Great Explorers: Marco Polo*. Chicago: Children's Press, 1992.

Masefield, John. *The Travels of Marco Polo*. New York: Dorset Press, 1987.

Preston, Edna Mitchell. *Marco Polo: A Story of the Middle Ages*. New York: Crowell-Collier Press, 1968.

Vincini Marri, Noemi. *Why They Became Famous Series: Marco Polo*. Silver Burdett Company, 1985.

Waugh, Teresa. *The Travels of Marco Polo*. New York: Facts on File Publications, 1984.

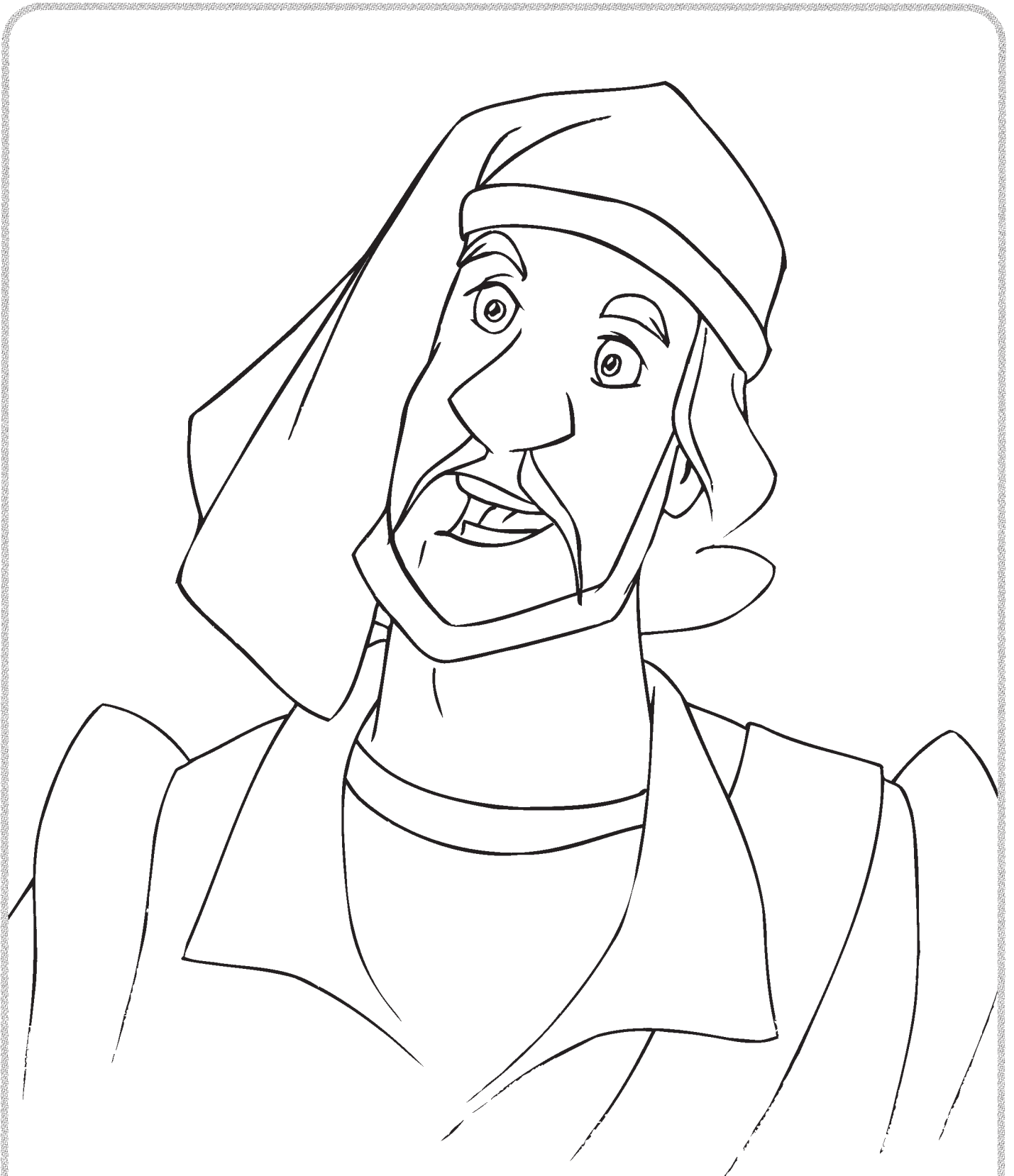

**Marco Polo inspires explorers  
for many centuries.**



# HOW DID HE TRAVEL?

Marco Polo traveled over deserts, mountains, seas, and jungles. Look at the pictures. If the picture shows how he could have traveled, color it.

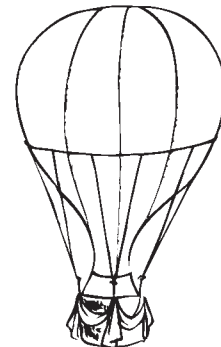
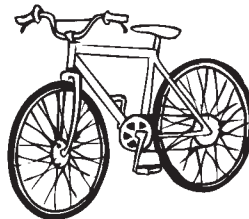
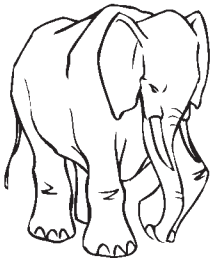
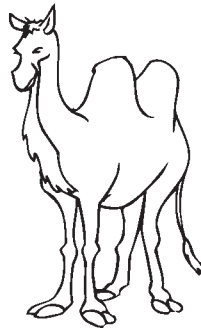
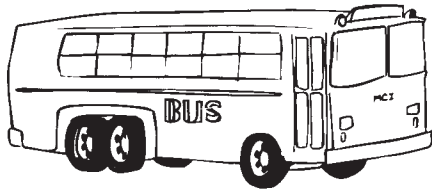
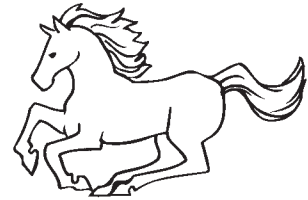
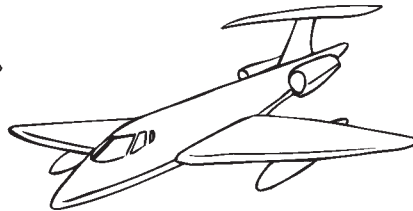

# DOT-TO-DOT

For his years of service, Marco Polo was given many precious gems by Kublai Kahn. Find the treasure by connecting the dots.

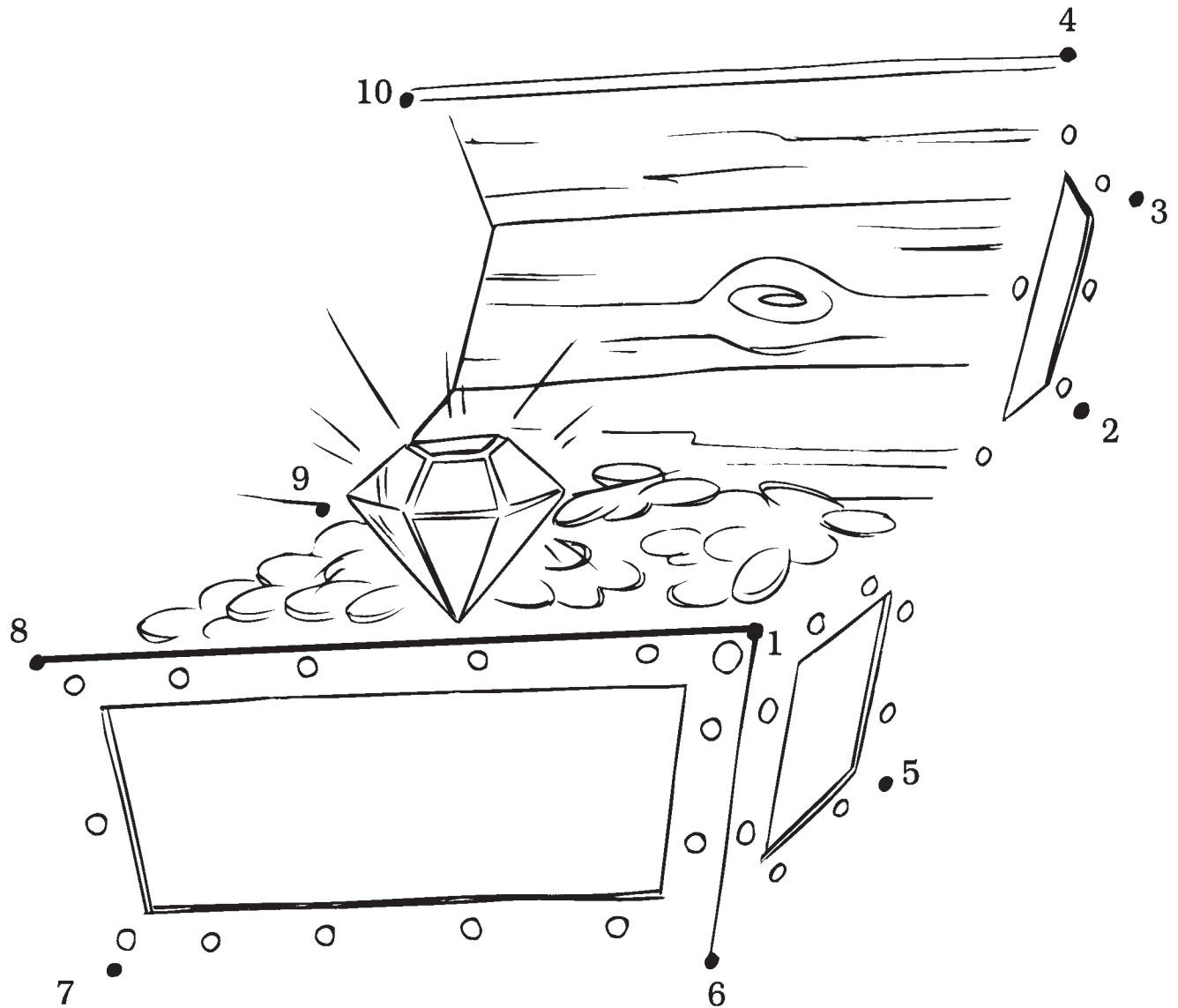



# BREAK THE CODE



After years of dangerous traveling, what problem did Marco face at home?

Look at the coded letters. Copy the correct letter on the blank over the code to find the problem.

C O D E B O X															
A	D	E	G	H	I	L	N	O	P	R	S	T	U	W	Y

\_\_\_\_\_

\_\_\_\_\_

\_\_\_\_\_

\_\_\_\_\_

\_\_\_\_\_

\_\_\_\_\_

\_\_\_\_\_

\_\_\_\_\_

\_\_\_\_\_

\_\_\_\_\_





**“China is a land of immense  
wealth and beauty.”**

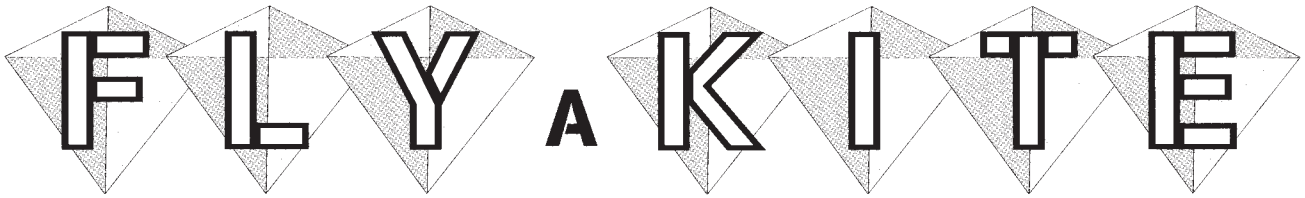

On Marco Polo's trip to China, he discovered many beautiful, brightly colored kites. Create your own design on the kite below.

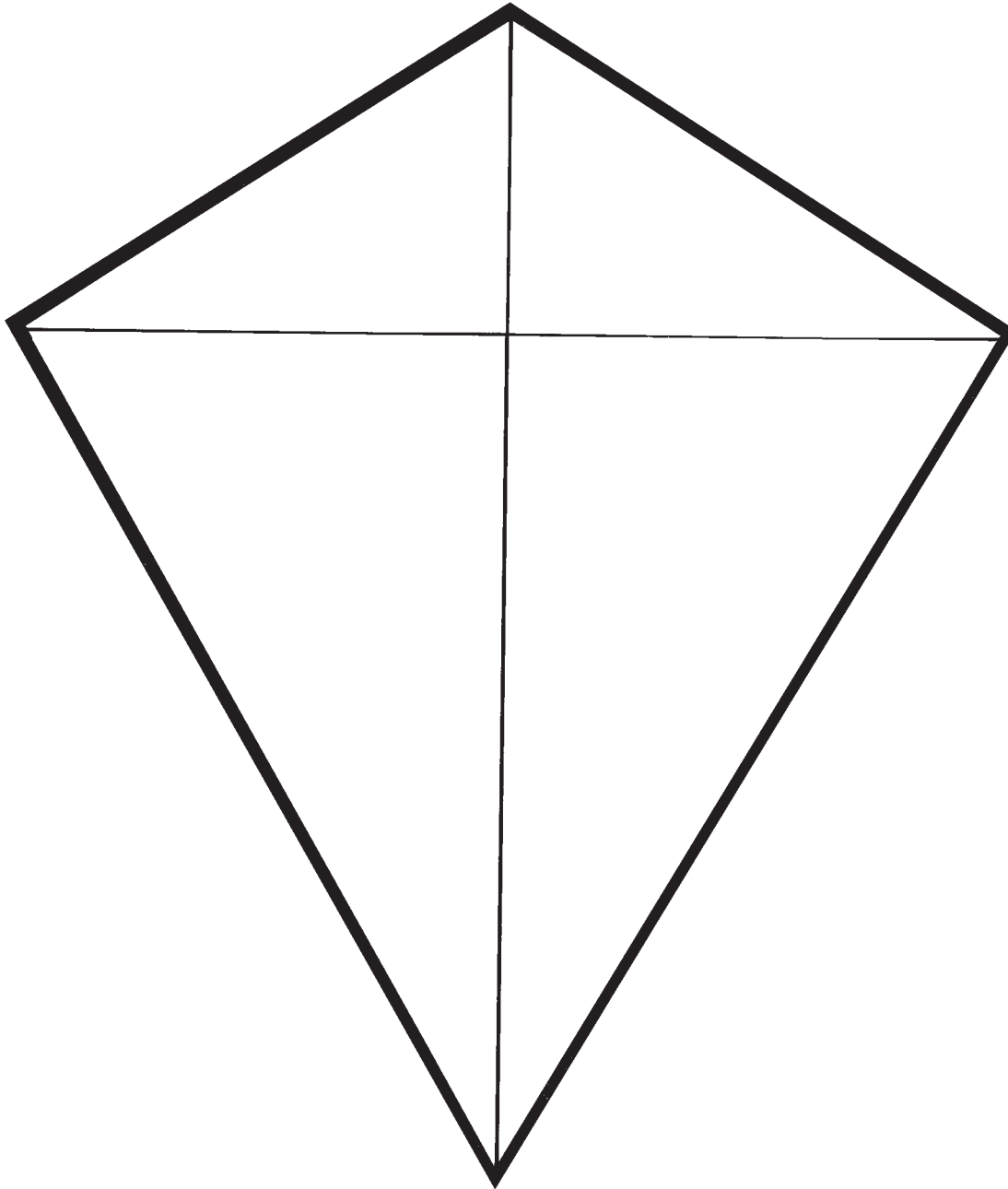



# The Proverb

Marco Polo's father taught him a proverb. He always remembered it and lived by its rule. To learn what the proverb was, color all squares that have an X, Y or Z in them. Then copy the remaining letters, in order from left to right on the lines below.

X	Y	Z	X	Y	Z	X	Y	Z	X	Y	Z	X	Y
Y	T	X	Y	H	X	E	X	Y	R	X	Y	E	X
Z	X	I	X	S	Z	X	Y	Z	X	A	X	Y	Z
X	P	Y	E	X	Y	A	X	Y	C	X	Y	Z	E
Y	Z	T	X	Y	H	Y	Z	A	X	Y	T	Y	Z
C	Y	Z	Y	Z	O	X	M	X	Y	E	Y	Z	S
X	Z	W	X	Y	Z	I	X	T	Z	Y	H	Y	X
Y	B	X	E	X	Y	Z	I	N	Y	Z	Y	Z	G
Z	X	H	X	O	X	Y	N	Z	E	X	S	Y	T
X	Y	Z	Z	X	Y	X	Y	X	Z	Y	Z	X	Y

Write the proverb here.

-----

-----

-----



# TREASURE

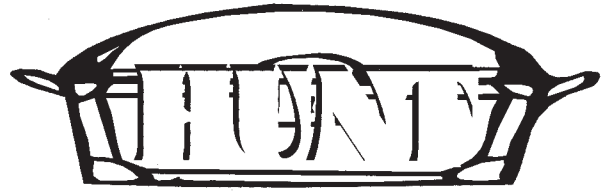

Marco Polo went from place to place looking for treasures. See how quickly you can complete the treasure hunt below. Have a friend or teacher sign a blank that applies to them.

Find someone who . . .

1. Has four living grandparents. \_\_\_\_\_
2. Can play a musical instrument. \_\_\_\_\_
3. Has curly hair. \_\_\_\_\_
4. Is wearing a belt. \_\_\_\_\_
5. Is wearing something red. \_\_\_\_\_
6. Has had stitches. \_\_\_\_\_
7. Is left-handed. \_\_\_\_\_
8. Can speak two languages. \_\_\_\_\_
9. Wears glasses. \_\_\_\_\_
10. Is on a sports team. \_\_\_\_\_
11. Has a pet. \_\_\_\_\_
12. Has freckles. \_\_\_\_\_
13. Shares a bedroom. \_\_\_\_\_
14. Has brown eyes. \_\_\_\_\_
15. Can draw a horse. \_\_\_\_\_
16. Can touch their nose with their tongue. \_\_\_\_\_



**“I die in peace, Marco. There is a peace that comes with being honest.”**



# IN SO MANY

## WORDS

Marco Polo had enthusiasm, curiosity, and a photographic memory. He also had a character quality that helped him through the trials and dangers he encountered on his twenty-five year trip. This character quality also helped him to advise the great Kublai Khan without fear. Find the character quality by following the steps below.

**STEP ONE:** Look at the four words in each box. Three of the words go together. Circle the number of the word that does not belong. Be careful! Some are tricky.

- 1. ships
- 2. sailor
- 3. sea
- 4. camel

- 5. Genghis Khan
- 6. Rusticello
- 7. Kublai Khan
- 8. Ogedai Khan

- 9. diamonds
- 10. rubies
- 11. paper
- 12. pearls

- 13. bandit
- 14. merchant
- 15. farmer
- 16. sailor

- 17. milk
- 18. coconuts
- 19. bricks
- 20. bread

- 21. camel
- 22. horse
- 23. elephant
- 24. tiger

**STEP TWO:** Find each number you circled in step one on the Letter Grid. Write the matching letter for each number you circled in a blank below the grid.

### LETTER GRID

7	13	1	4	17	11	16	6	18	19	23	24
T	N	U	I	B	V	D	O	A	S	E	I

— — — — —

**STEP THREE:** Unscramble the letters to find the character quality that Marco Polo had. Copy the letters on the blanks below to complete the sentence.

— — — — — is what drives great explorers like Marco Polo to leave the familiar to seek new lands and opportunities that forever change our world.



# P I C T U R E P U Z Z L E

There was a famous drink that the Mongolian tribes drank. What was the name of it? Write the name of the object on the lines. Copy the numbered letters over the numbered blanks.



7 14 2 — 8 9



5 — — — — 13 4

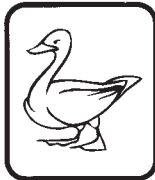

12 3 — 1



17 — 11



15 — 16

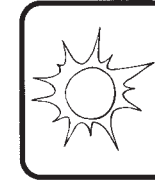

6 — 10

What was the name of it? 1 2 3 4 5 6 6

What was it?

7 8 9 4 8 10 11 8 12  
,  
4 13 9 8 6 4 5 14 1

It came only from:

15 3 9 8 16 17 5 11 8 4 13 9 8 6



**“These Venetians are such fantastic liars,” says the Duke of Genoa.**





# TIME LINE

## SCRAMBLE

Find out what happened in the life of Marco Polo and when it happened by completing the time line below. Fill in the blanks by unscrambling the words. If you need help, the words are in the Word Box.

- 1227** \_\_\_\_\_ (ihsGeng hanK), the great founder of the Mongol Empire, dies.
- 1254** Marco Polo, son of Nicolo, is born in \_\_\_\_\_ (ceVnei).
- 1257** \_\_\_\_\_ (blaiKu naKh), the grandson of Genghis Khan, becomes leader of the Mongol Empire.
- 1260-69** Nicolo Polo and his brother Maffeo travel to \_\_\_\_\_ (thCaay), another name for China, making friends with Kublai Khan.
- 1269** Nicolo and Maffeo return to Venice with a message from Kublai Khan for the \_\_\_\_\_ (peoP).
- 1271** Nicolo and Maffeo leave Venice with the young \_\_\_\_\_ (arMoc), carrying a message from the Pope to Kublai Khan.
- 1274** The Polos reach Cathay and are \_\_\_\_\_ (mdelwoce) by Kublai Khan.
- 1295** The Polos return to Venice after being away \_\_\_\_\_ (newtyt-vife) years.
- 1298** Marco is taken \_\_\_\_\_ (sonprire) during the war between Venice and Genoa.
- 1299** Marco is freed and comes out of prison with a book written there by \_\_\_\_\_ (tiRuslolec) about his travels.
- 1324** Marco Polo dies, but his book inspires many \_\_\_\_\_ (ploexerrs).

### WORD BOX

- |                 |                |                |
|-----------------|----------------|----------------|
| __ explorers    | __ Kublai Khan | __ welcomed    |
| __ Cathay       | __ Venice      | __ Rusticello  |
| __ Marco        | __ Pope        | __ twenty-five |
| __ Genghis Khan | __ prisoner    |                |



# GRID CODE

Kublai Khan awarded the Polos with many treasures for all of their years of service. The return trip to Venice was very dangerous. Where did they hide their jewels from bandits? Decode the message below to find the answer. Use the Grid Code Box to find the correct letters to fill in the blanks.

<i>GRID CODE BOX</i>				
	1	2	3	4
A	E	O	C	B
B	I	H	R	L
C	S	F	K	G
D	N	P	T	A

B1 D1      D3 B2 A1

B4 B1 D1 B1 D1 C4      A2 C2

D3 B2 A1 B1 B3

A3 A2 D4 D3 C1



# DMWORDSEARCHGH

Find the words from the word box in the grid. They may be forward, backward, up, down, or diagonal.

M A R C O P O L O B U R J E W E L S  
 T O U N M E R C O C O N U T S B O H  
 K U B L A I K H A N N E N P A L R I  
 N R Y K N T B I R C U P G O L D K P  
 I D N D B A W N C L M O L V O M S S  
 C I I R O L S A B A B V E N I R T K  
 O A S I S Y B N K I P N R D E N O W  
 L M K B N C R P D A I B N D T B R S  
 O O R P O E P E L C R N A U L D Y K  
 B N C E S D S A E H A R R E S O T B  
 K D B O I E C R A N T K D L E C E R  
 D S T N R E D L R K E T N C B D L M  
 C M O T P O N S M Y S A I L O R L O  
 R P L D U C H E S S P L B N R T E L  
 B D O E F F A M E L C N U P B N R W

- |                 |            |                 |             |            |                  |
|-----------------|------------|-----------------|-------------|------------|------------------|
| ___ China       | ___ gold   | ___ jungle      | ___ palace  | ___ robes  | ___ storyteller  |
| ___ coconuts    | ___ India  | ___ Kublai Khan | ___ pearls  | ___ ruby   | ___ traders      |
| ___ diamonds    | ___ Italy  | ___ Marco Polo  | ___ pirates | ___ Saba   | ___ Turkey       |
| ___ duchess     | ___ jewels | ___ Nicolo      | ___ prison  | ___ sailor | ___ Uncle Maffeo |
| ___ Gobi Desert |            | ___ oasis       |             | ___ ships  | ___ Venice       |



**The great Kublai Khan  
sits on his throne.**



# Origami

In China, Marco Polo would have seen origami, or artwork created by folding paper. To make an origami creation, start with a square piece of paper. Then follow the directions of the diagram to make an origami dog. Draw the eyes and nose.

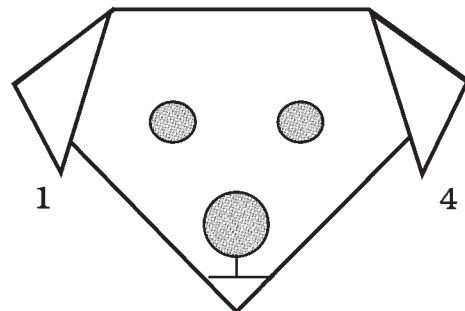
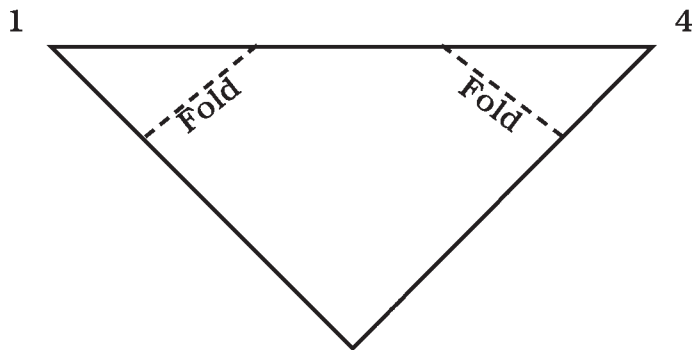
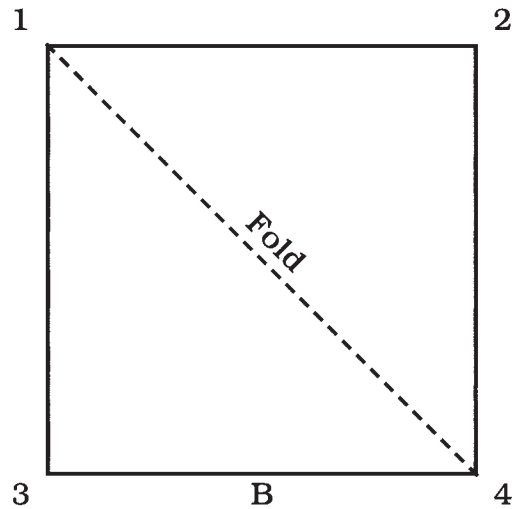
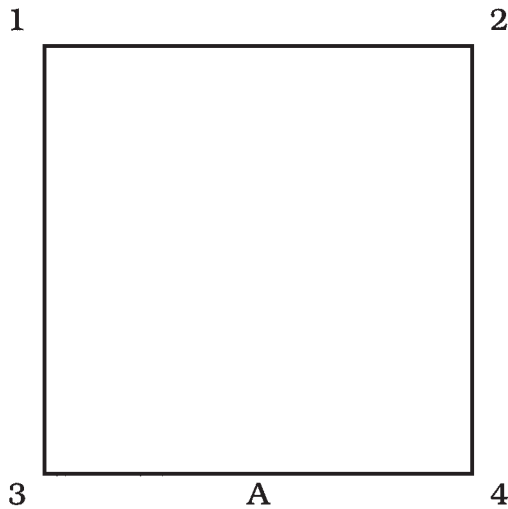

By making a few changes, what other animals can you make?



# MARCO'S MISSION

Marco Polo went on an adventure-filled trip when he was only seventeen. He saw things that were so incredible that no one believed his accounts when he returned home. Discover some of the countries that he visited by solving the puzzle below. The names of the countries are what they are called today.

**STEP ONE:** Look at the words in the Word Box. Follow the instructions.

**WORD BOX**

Afghanistan

China

India

Israel

Italy

Mongolia

Sumatra

Thailand

Turkey

Draw a | | around all words with seven letters.

Draw a □ around a five-letter word that starts with a consonant.

Draw a ▱ around a six-letter word that starts with a vowel.

Draw a ○ around all words that start with the letter I.

Draw a ◇ around a word that ends with KEY.

Draw a □ around the longest word.

Draw a △ around a five-letter word that ends with Y.

Draw a □ around a word that has MAT in it.

Draw a △ around a word that ends with LAND.

Draw a ○ around all words with eight letters.

Clue: Some words may have two symbols.

**STEP TWO:** Match the symbols before the blanks with the symbols drawn around the words in the Word Box. Write the correct words on the blanks to learn which countries Marco visited.

Marco left his home in Venice, △ \_\_\_\_\_, with his father and uncle and headed east across the Mediterranean Sea to ▱ \_\_\_\_\_. There they obtained a flask of holy oil for the Kublai Khan. Traveling farther east through □ \_\_\_\_\_, the group was attacked by bandits. Then Marco became very ill in the desert of ○ \_\_\_\_\_. They finally made it to Kublai Khan's palace in □ \_\_\_\_\_. The Khan liked Marco so much he sent him on exploring missions. It was on the island of □ \_\_\_\_\_ that orangutans threw coconuts at Marco and his guide. In the jungle of △ \_\_\_\_\_, Marco discovered a cave full of glittering jewels. However, one of the most frightening times was when tigers attacked him and his guide in ○ \_\_\_\_\_. After twenty-five exciting years, the Polos caught a ship out of ◇ \_\_\_\_\_ and headed home.

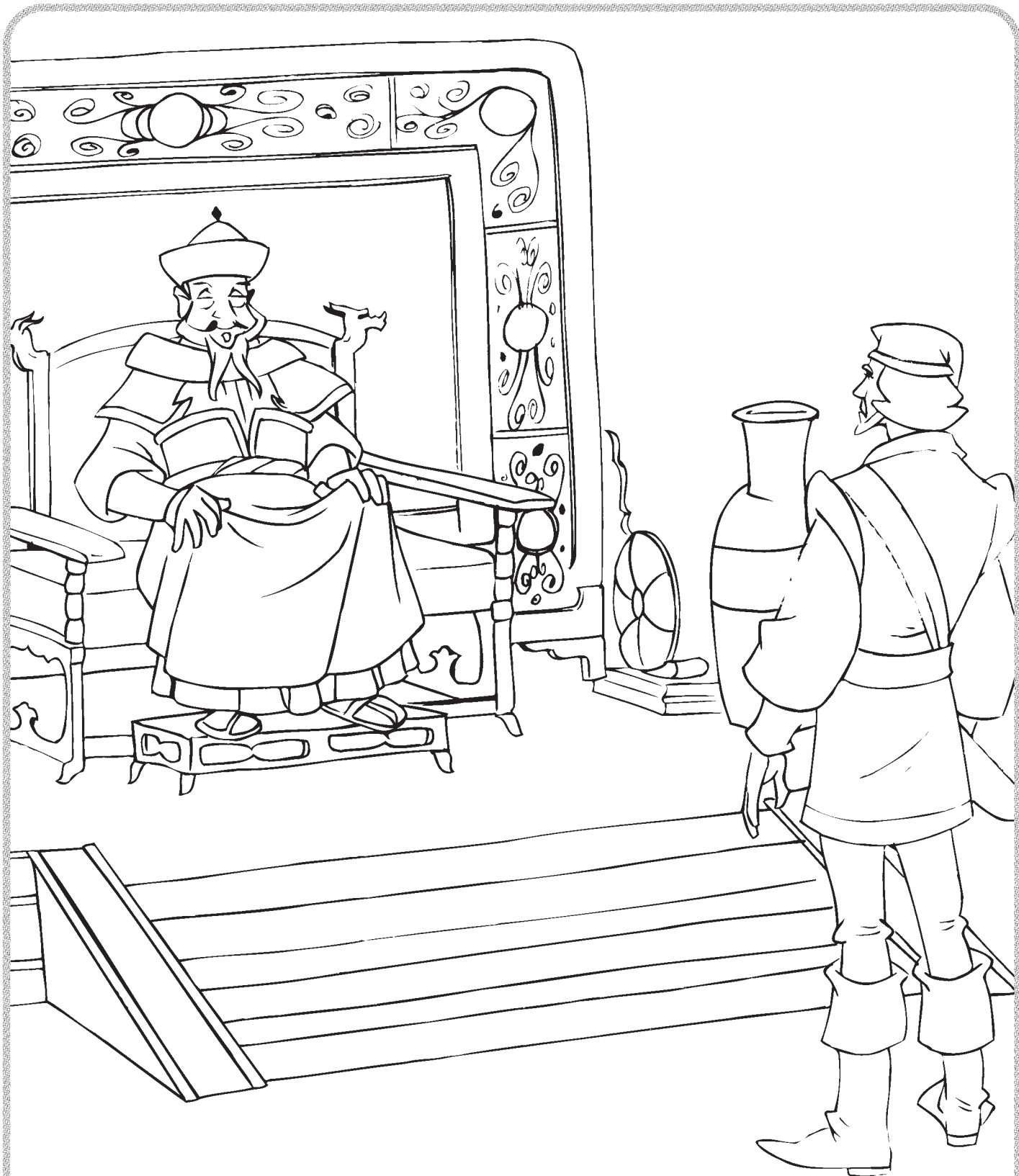

**“Marco, I want you to explore the unknown areas of this kingdom.”**



# POLO PRESS

SPECIAL EDITION

VENICE, ITALY

OCTOBER 1295

PAGE ONE

Complete the articles and ads. Illustrate where needed.

## MARCO POLO VISITS CHINA

By \_\_\_\_\_

*Reports from China are unbelievable! According to world traveler, Marco Polo . . .*

## WEATHER FORECAST

*The traveling forecast looks . . .*

*Yesterday it rained cats and dogs, causing . . .*

---

## HELP WANTED

*Sales position available. Traveling required. Job duties include . . .*





VENICE, ITALY

OCTOBER 1295

SPECIAL EDITION

Complete the articles and ads. Illustrate where needed.

POLO TEAM WINS AGAIN!

For the tenth straight week, the Polo team has beaten . . .

Direct from the Orient:

BIG TENT SALE!

MOVIE GUIDE

Coming Soon -

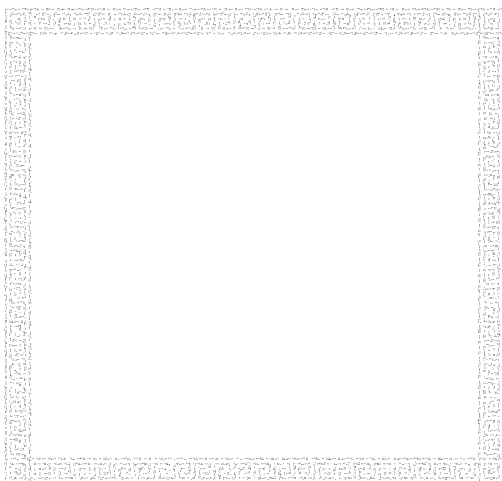

CROSSWORD PUZZLE

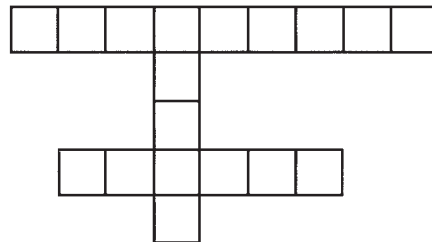

Answers:

Venice      China  
Marco Polo



# Who Were They?

Marco Polo had many friends during his lifetime. But he had many enemies, too. Look at each picture. If it shows a friend of Marco's, circle the yes box and color the picture. If it shows an enemy, circle the no.



**YES**    **Duchess of Genoa**    **NO**



**YES**    **Kublai Khan**    **NO**



**YES**    **Duke of Genoa**    **NO**



**YES**    **Rusticello**    **NO**



**YES**    **Nayan and Kaidu**    **NO**



**YES**    **Saba**    **NO**

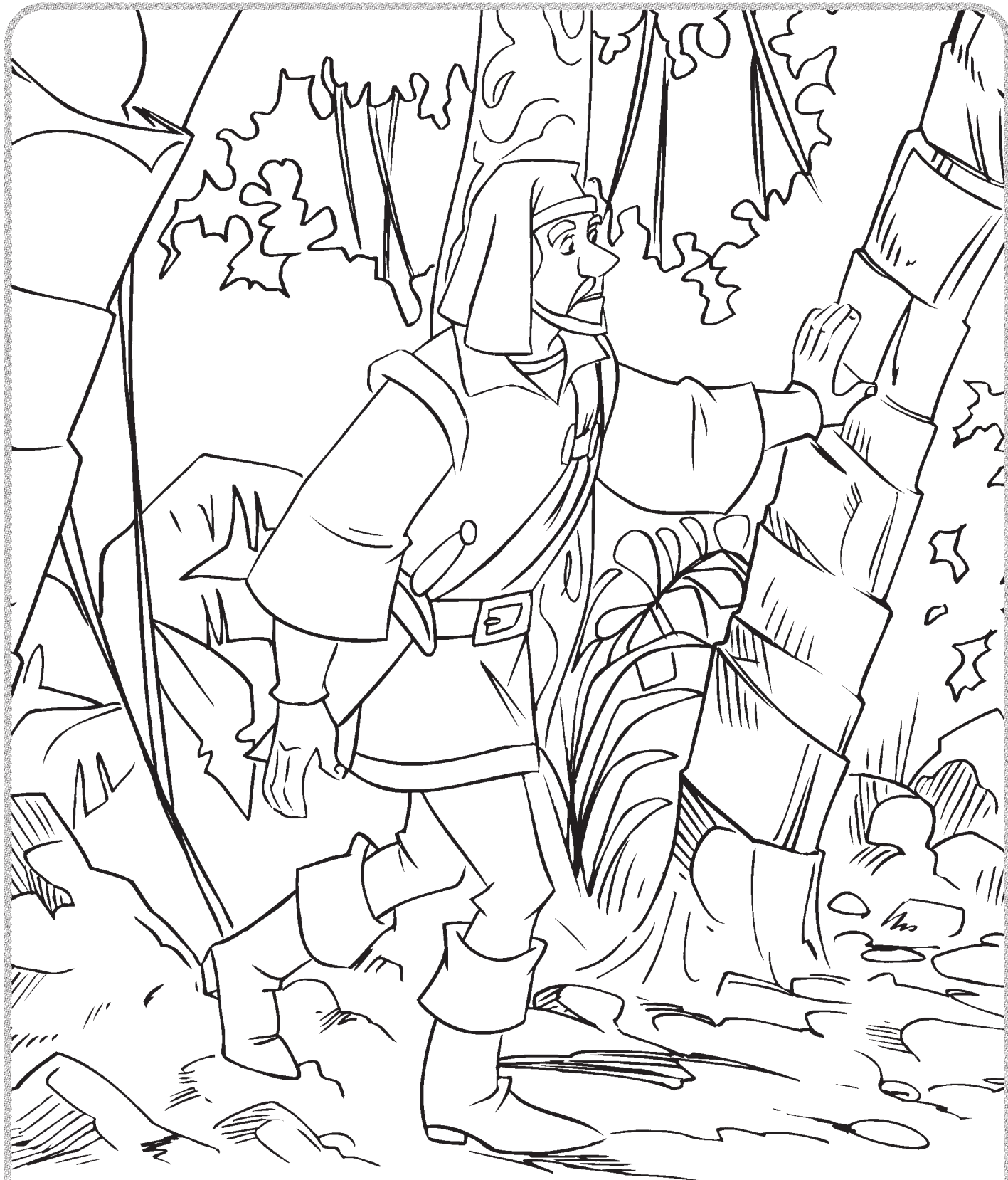

**Marco explores the jungles of  
Kublai Khan's kingdom.**



# MATCH-UPS

All of the words below are from the story of Marco Polo. Match the words on the left with the words on the right that give the definition or the place where it is found. Write the correct number on the space before the words on the right.

- |                 |     |                    |
|-----------------|-----|--------------------|
| 1. alligators   | ___ | Genoa Palace       |
| 2. ammunition   | ___ | jungle knife       |
| 3. duchess      | ___ | mountains (Pamirs) |
| 4. Kublai Khan  | ___ | “logs with eyes”   |
| 5. machete      | ___ | coconuts           |
| 6. magicians    | ___ | Gobi Desert        |
| 7. pearl divers | ___ | Genoa              |
| 8. pearls       | ___ | prison             |
| 9. pure air     | ___ | China              |
| 10. Rusticello  | ___ | Kublai’s court     |
| 11. sickness    | ___ | coast of India     |
| 12. war         | ___ | oysters (clams)    |



# WORD SCRAMBLE

Who or what am I? Unscramble each word on the right to answer the questions on the left. Your answers will be the names of things Marco Polo discovered in his travels.

1. I am a large cat with black stripes. *What am I?* **G I E R T**  
\_\_\_\_\_

2. I'm a nut that grows high in the tops of trees. Split me open and you can drink my milk. *What am I?* **O O C C T U N**  
\_\_\_\_\_

3. I am a large, fierce cat with black spots. I live in Africa and southern Asia. *What am I?* **P A R D L O E**  
\_\_\_\_\_

4. I live in the sea. Inside of me you will find a precious gem used to make necklaces. *What am I?* **Y S T O E R**  
\_\_\_\_\_

5. I am what orangutans like to eat. To eat me, you must first peel me. Step on my peel and you will slip. *What am I?* **N A B A N A**  
\_\_\_\_\_

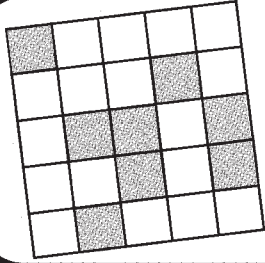

# Crossword Puzzle

## ACROSS

- 1. Traveler to China
- 4. Marco's father.
- 7. Small rodent.
- 8. Means of transportation.
- 9. Marco's birthplace.
- 11. Robbers on the seas.
- 16. "Log with eyes."
- 18. A red jewel.
- 20. Marco's Indian guide.
- 21. A jewel.
- 22. Rich, yellow metallic element.
- 23. A robber.
- 25. Nicolo's occupation.
- 26. Marco was called a \_\_\_.

## DOWN

- 1. Large knife.
- 2. A means of transportation across the desert.
- 3. Watered area in the desert.
- 5. Ammunition for the orangutan.
- 6. Ruler of the Chinese.
- 10. Country of Venice.
- 12. Sea-going vessel.
- 13. A king's home.
- 14. Kublai's country.
- 15. Land densely covered by tropical vegetation.
- 17. Threw coconuts at Marco.
- 19. A ship's crew.
- 21. A desert Marco crossed.
- 24. Dry, sandy, barren region.

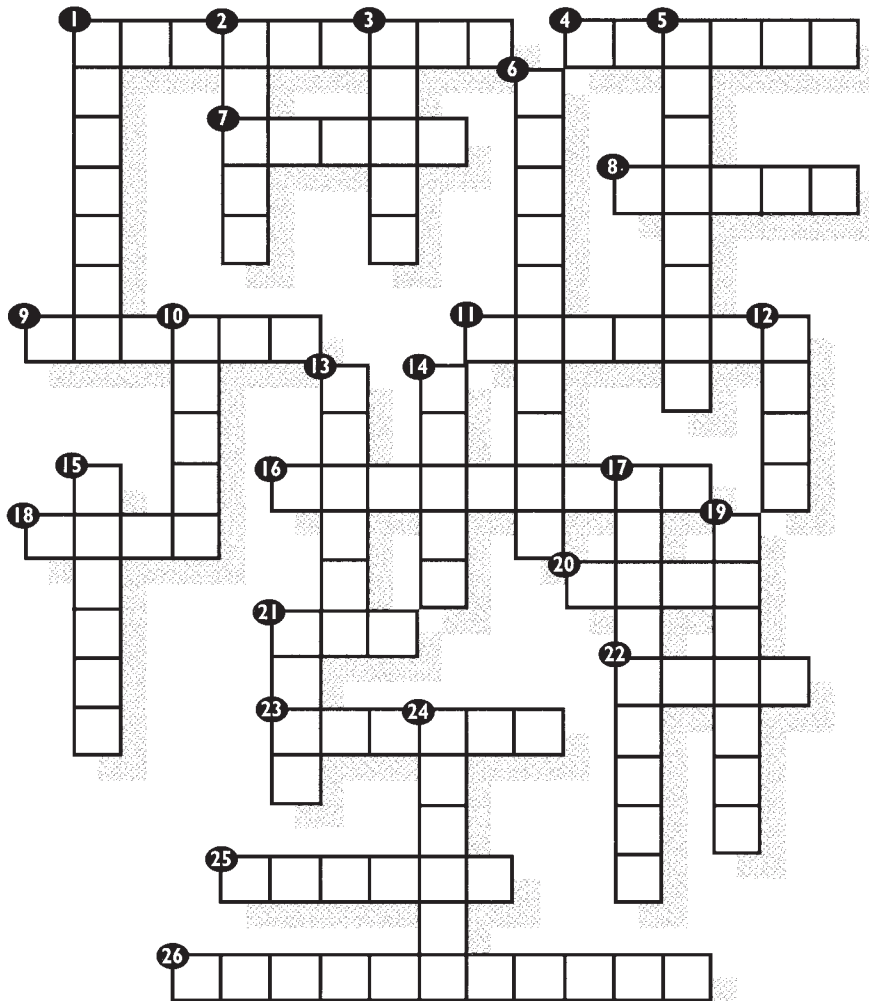



**Kaidu and Nayan want Marco  
to help them kill Kublai Khan.**







# Match the Continents



Marco Polo traveled thousands of miles across Europe and Asia. Match the country or city that he visited with the continent where it is found by drawing a line.

AFGHANISTAN

VENICE

SHANGTU

CHINA

ITALY

PORTUGAL

MONGOLIA

INDIA

SPAIN

GENOA

EUROPE

ASIA

### *Bonus Question:*

Can you name all seven continents?

- 1. \_\_\_\_\_
- 2. \_\_\_\_\_
- 3. \_\_\_\_\_
- 4. \_\_\_\_\_
- 5. \_\_\_\_\_
- 6. \_\_\_\_\_
- 7. \_\_\_\_\_



# MIX 'N' MATCH CODE

Do you know the name of the most famous and influential book of the Middle Ages (A.D. 500-1500)? It inspired explorers, such as Christopher Columbus, to search for Marco Polo's land of wealth and wonder.

Break the code below by matching the letters under the blanks with another letter in the Code Box. Write the matching letter on the blanks to discover a very famous book.

CODE BOX																									
A	B	C	D	E	F	G	H	I	J	K	L	M	N	O	P	Q	R	S	T	U	V	W	X	Y	Z
Z	Y	X	W	V	U	T	S	R	Q	P	O	N	M	L	K	J	I	H	G	F	E	D	C	B	A

G S V      G I Z E V O H      L U

N Z I X L      K L O L

*This book was written in prison by Rusticello as he listened to the stories of Marco Polo.*



**Marco and Rusticello are imprisoned after losing the war with Genoa.**



Because of the fascinating travels of Marco Polo, many other explorers set sail around the world. Circle the first letter at the arrow. Then, move clockwise, circling every third letter, and discover the name of a famous explorer who also went to China.

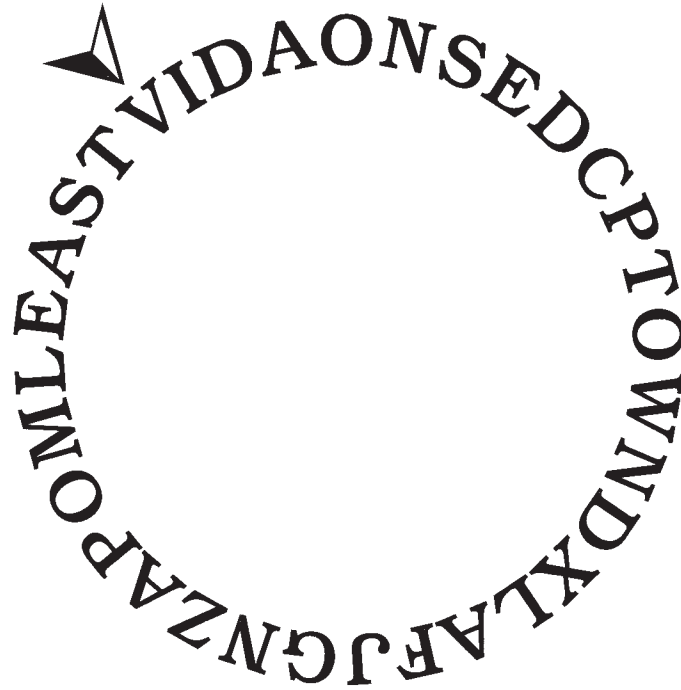

*This explorer set sail in 1498. Inspired by Polo's description of an all-sea route to China, he sailed around Cape Horn and rediscovered the East.*

*His name was*

\_\_\_\_\_.



# ALPHABETICAL DISCOVERIES

During Marco Polo's lifetime, China was an advanced society. The words below were a part of the Chinese culture at that time. Practice your alphabetizing skills by numbering the words in each box from 1-10 to place them in alphabetical order.

1

- \_\_\_ postal system
- \_\_\_ Kublai Khan
- \_\_\_ rhubarb
- \_\_\_ silver
- \_\_\_ astronomers
- \_\_\_ herbs
- \_\_\_ magicians
- \_\_\_ fire departments
- \_\_\_ astrologers
- \_\_\_ Wall of China

2

- \_\_\_ rice
- \_\_\_ diamonds
- \_\_\_ noodles
- \_\_\_ cinnamon
- \_\_\_ iron
- \_\_\_ silk
- \_\_\_ furs
- \_\_\_ gold
- \_\_\_ coal
- \_\_\_ spices

3

- \_\_\_ horses
- \_\_\_ paved streets
- \_\_\_ puzzles
- \_\_\_ origami
- \_\_\_ tops
- \_\_\_ tangrams
- \_\_\_ POGS
- \_\_\_ fire works
- \_\_\_ camels
- \_\_\_ kites

4

- \_\_\_ dried milk
- \_\_\_ printed money
- \_\_\_ pearls
- \_\_\_ emeralds
- \_\_\_ jade
- \_\_\_ sapphires
- \_\_\_ bath houses
- \_\_\_ wealth
- \_\_\_ liquid fuel
- \_\_\_ ice cream



# MAP IT

Because of Marco Polo's travels, geographers were able to create maps to help other travelers. Practice your mapping skills by drawing a map of your neighborhood block below. Include houses, buildings, streets, and other landmarks on your block.

## *My Block*



**“Here is the book I wrote in prison.  
It’s the book I always wanted to write.  
But it belongs to you. It’s your  
story - *The Travels of Marco Polo.*”**



# TRUE

OR



# FALSE

**Read each sentence below. If it is true, circle the T. If it is false, circle the F.**

1. Marco Polo's home was in Venice, Italy. T F
2. Marco, his father, and uncle were gone for twenty-five years. T F
3. Marco said he saw men with tails. T F
4. Marco said they saw gold growing in trees. T F
5. The Polos had traveled to China. T F
6. Soon after they returned, their country went to war with Genoa. T F
7. Marco fought in the war. T F
8. Venice won the war. T F
9. Marco was put in prison in Genoa. T F
10. The Duchess of Genoa had heard of Marco. T F
11. She wanted to hear about his travels. T F
12. The Duke would not let her hear Marco's stories. T F
13. Marco told of being attacked by bandits. T F
14. It took four years to reach Khan's palace. T F
15. Kublai Khan was a very kind ruler. T F





# TITLE TAG

When Marco was taken captive in the battle between Venice and Genoa, he was asked to tell his stories to the Duke and Duchess. Rulers of countries have different titles or names. Look at the titles listed below. Match up the male titles in Column A to their female counterparts in Column B by drawing a line.

## Column A

DUKE

PRINCE

KING

COUNT

SEÑOR

LORD

SIR

CZAR

## Column B

DUCHESS

LADY

PRINCESS

QUEEN

CZARINA

MADAME

COUNTESS

SEÑORA

## *Did You Know?*

The word “khan” is not a personal name. It was the title for Chinese emperors of the Middle Ages. “Khanate” was the area ruled by a khan. That is why Genghis and his grandson, Kublai, were called Khan.

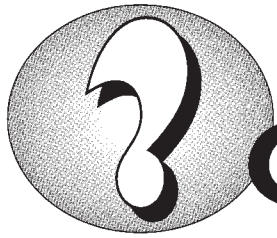

# MARCO POLO QUESTIONS

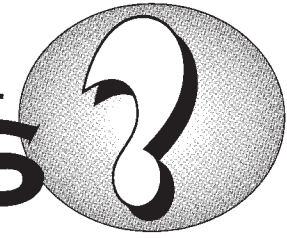

1. Where was Marco Polo born?
2. With whom did Marco Polo travel?
3. How long were the Polos gone?
4. Where were they going?
5. Who were they going to see?
6. How long did it take them to get there?
7. What were four precious jewels they saw?
8. How did Saba, the guide, save them from a tiger attack?
9. What protection did the Polos have from bandits?
10. What caused Marco's sickness in the Gobi Desert?
11. How did Marco get well?
12. In what way did Khan show that he liked and trusted Marco?
13. Why did the Polos want to leave China?
14. How did Kublai Khan reward Marco for his faithful work?
15. Soon after their return home, what event happened that changed their lives?
16. Who won the war?
17. Where was Marco when his stories were being written?
18. Who asked Marco to tell his stories about his travels?
19. Who wrote the stories of Marco's travels?
20. What was the most famous and influential book of the Middle Ages?



# THINGS TO THINK ABOUT & DO

**NOTE TO THE TEACHER:** These are activities for group discussion with additional projects to go along with the story of Marco Polo.

1. Marco Polo met all kinds of people from different places all around the world, but he never let their differences keep him from making friends. Do you sometimes hesitate to make friends with others because they don't look like you do? Or they speak with an accent? Or have different customs? What are some of the ways you can show your friendliness to others who appear different from you?
2. Nicolo Polo taught his son, Marco, that if you live your life with honor you will have peace in your heart. What does the word "honor" mean to you? Why do you think it is important to be an honorable person? How does living with honor give peace to your heart?
3. Imagine that you are Marco Polo on one of his great adventures. Design a treasure map based upon your neighborhood. Make a treasure chest and hide it somewhere, then mark it on your map. Invite some of your friends over and give them the map to see if they can find the treasure chest. Be sure to put something fun in the treasure chest.
4. Rusticello wrote down the exciting adventures of Marco Polo so that others could read about his life for years to come. Many who read his book became explorers. Interview several adults (teacher, parents, neighbor, grandparents, etc.) and ask them about their most exciting adventures. Then put together a book about their lives. Be sure to add some colorful pictures.
5. Compare the adventures of Marco Polo with those of the first men who flew to the moon. Was a trip to China just as unbelievable as a trip to the moon? What kind of dangers were encountered on both trips? How did people react to Marco Polo and his stories? How did people react to the astronauts upon their return?



# ANSWER KEY

## **HOW DID HE TRAVEL? — PAGE 6**

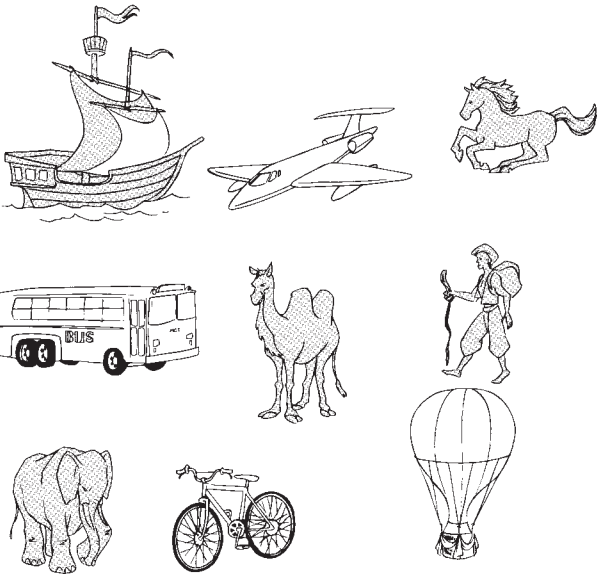

## **DOT-TO-DOT — PAGE 7**

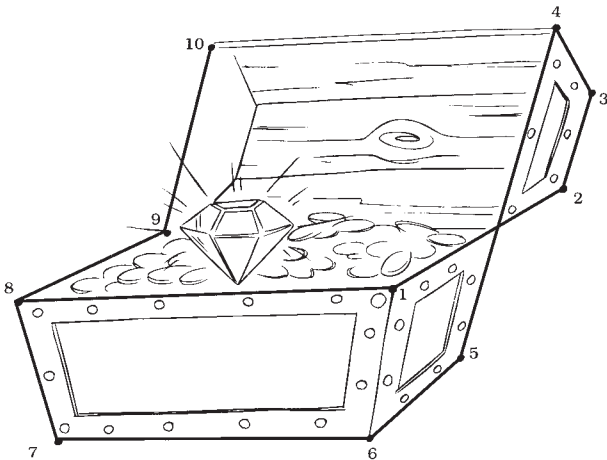

## **BREAK THE CODE — PAGE 8**

*People laughed at his stories  
and said he was lying.*

## **THE PROVERB — PAGE 11**

*There is a peace  
that comes with  
being honest.*

## **IN SO MANY WORDS — PAGE 14**

*IOVSIN  
VISION*

## **PICTURE PUZZLE — PAGE 15**

*flower            hat  
ice cream        paw  
duck              sun*

*koumiss  
fermented mare's milk  
pure white mares*

## **TIME LINE SCRAMBLE — PAGE 17**

*Genghis Khan  
Venice  
Kublai Khan  
Cathay  
Pope  
Marco  
welcomed  
twenty-five  
prisoner  
Rusticello  
explorers*

## **GRID CODE — PAGE 18**

*In the  
lining of  
their coats.*

**WORD SEARCH — PAGE 19**

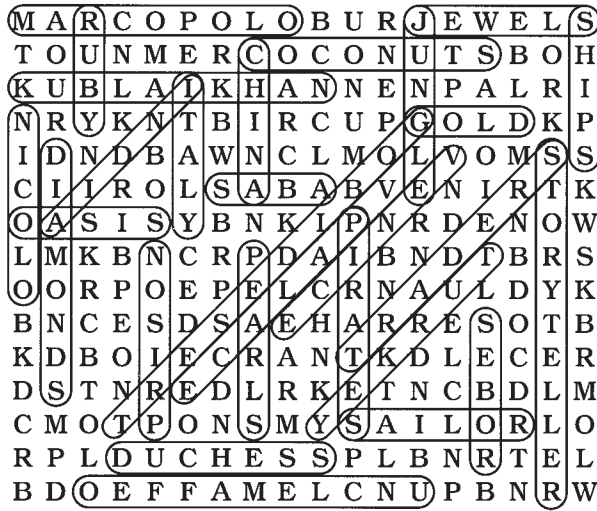

**MARCO'S MISSION — PAGE 22**

- Italy
- Israel
- Afghanistan
- Mongolia
- China
- Sumatra
- Thailand
- India
- Turkey

**POLO PRESS — PAGE 25**

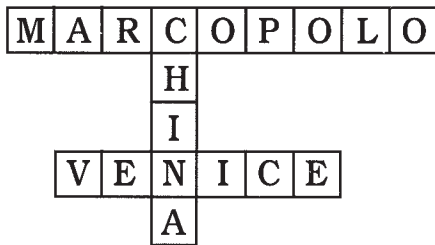

**WHO WERE THEY? — PAGE 26**

- |                        |                        |
|------------------------|------------------------|
| <b>Marco's Friends</b> | <b>Marco's Enemies</b> |
| Duchess of Genoa       | Duke of Genoa          |
| Kublai Khan            | Nayan and Kaidu        |
| Rusticello             |                        |
| Saba                   |                        |

**MATCH-UPS — PAGE 28**

3. Genoa Palace
5. jungle knife
9. mountains (Pamirs)
1. "logs with eyes"
2. coconuts
11. Gobi Desert
12. Genoa
10. prison
4. China
6. Kublai's court
7. coast of India
8. oysters (clams)

**WORD SCRAMBLE — PAGE 29**

1. tiger
2. coconut
3. leopard
4. oyster
5. banana

**CROSSWORD PUZZLE — PAGE 30**

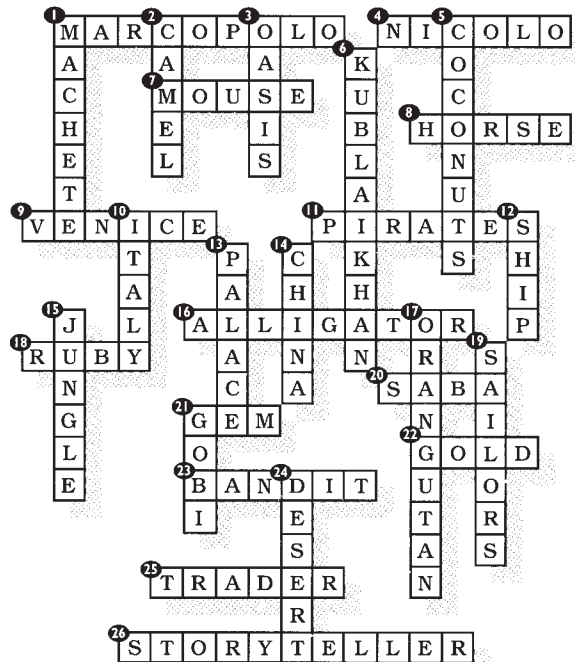

**MATCH THE CONTINENTS — PAGE 33**

**EUROPE:**

Venice  
Italy  
Portugal  
Spain  
Genoa

**ASIA:**

Afghanistan  
Shangtu  
China  
Mongolia  
India

Africa Antarctica Asia Australia  
Europe North America South America

**MIX 'N' MATCH CODE — PAGE 34**

The Travels of Marco Polo

**CIRCLE MAZE — PAGE 36**

Vasco Da Gama

**ALPHABETICAL DISCOVERIES**

— PAGE 37

**1.**

1. astrologers
2. astronomers
3. fire departments
4. herbs
5. Kublai Khan
6. magicians
7. postal system
8. rhubarb
9. silver
10. Wall of China

**2.**

1. cinnamon
2. coal
3. diamonds
4. furs
5. gold
6. iron
7. noodles
8. rice
9. silk
10. spices

**3.**

1. camels
2. fire works
3. horses
4. kites
5. origami
6. paved streets
7. POGS
8. puzzles
9. tangrams
10. tops

**4.**

1. bath houses
2. dried milk
3. emeralds
4. ice cream
5. jade
6. liquid fuel
7. pearls
8. printed money
9. sapphires
10. wealth

**TRUE OR FALSE — PAGE 40**

- |      |       |       |
|------|-------|-------|
| 1. T | 6. T  | 11. T |
| 2. T | 7. T  | 12. F |
| 3. F | 8. F  | 13. T |
| 4. F | 9. T  | 14. T |
| 5. T | 10. T | 15. T |

**TITLE TAG — PAGE 41**

DUKE - DUCHESS  
PRINCE - PRINCESS  
KING - QUEEN  
COUNT - COUNTESS  
SEÑOR - SEÑORA  
LORD - LADY  
SIR - MADAME  
CZAR - CZARINA

**QUESTIONS — PAGE 42**

1. Marco Polo was born in Venice, Italy.
2. He traveled with his father, Nicolo, and his uncle, Maffeo.
3. The Polos were gone for twenty-five years.
4. They were going to China.
5. The Polos were going to see Kublai Khan, whom they had met on an earlier trip.
6. It took four years to get to China from Venice.
7. They saw gold, pearls, diamonds, and rubies.
8. Saba burned bamboo that exploded and scared the tigers.
9. Kublai Khan gave them a tablet of gold with words written saying they were friends of Kublai Khan and not to be harmed.
10. Marco became sick in the desert from breathing sand and having no water to drink.
11. Marco was taken to the Pamir Mountains to breathe pure air.
12. Kublai Khan asked Marco to explore the unknown areas of his kingdom.
13. The Polos knew Kublai Khan was old and would die soon and that the next ruler might be cruel and make them stay in China.
14. Kublai Khan awarded Marco with a chest full of jewels.
15. War broke out between Genoa and Venice.
16. Genoa won the war and Marco was taken prisoner.
17. Marco Polo was in prison.
18. The Duchess of Genoa asked Marco to tell his stories.
19. Rusticello, a fellow prisoner, wrote Marco's stories.
20. The Travels of Marco Polo was the most famous and influential book of the Middle Ages.

# Certificate of Achievement

This certifies that

\_\_\_\_\_

has mastered the

## Marco Polo

RESOURCE & ACTIVITY

from NEST Family Entertainment™

by successfully completing all of the puzzles, games, and activities found herein.

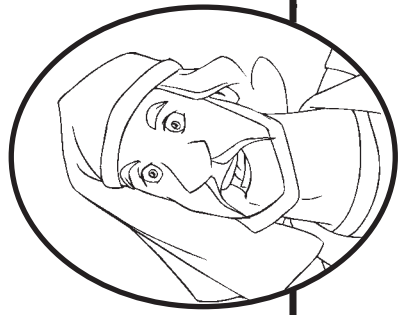

\_\_\_\_\_

As of this date

*NEST Family Entertainment*